THEATRELIGHT WALLPLATES - TABLE OF CONTENTS

THEATRELIGHT WALLPLATES	1	STAGE SHOWS WALLPLATES.....	23
Wallplate Electronics	1	SH1- Stage Single Show Wallplate	23
Power Supply	1	SH6- Stage Shows Wallplate	24
Communication	1	ENVIRON SOFTWARE	27
Connection and Wiring	2	Presets Attributes	27
Wallplate Software types	3	Environ Presets controllers	28
WALLPLATE CROSSFADES	4	Environ Links controllers	28
Time Proportional Crossfades	4	Remote controlled Presets	28
Constant Slope Crossfades	4	SETTING UP ENVIRON PRESETS WALLPLATES	29
Remote Up/Down fades	4	Dipswitch settings	29
STAGE SCENES SOFTWARE.....	5	Master switch	30
Scenes attributes	5	Terminating resistor	30
Shows and Chase attributes	6	ENVIRON PRESETS WALLPLATES.....	31
Stage Scenes controllers	6	EP6- Environ Presets Wallplate	31
Stage Links controllers	6	EPF4- Environ Presets Fade Wallplate	32
Stage Shows controllers	7	EA6- Environ Areas Wallplate	34
Remote controlled Scenes and Shows	7	EAF4- Environ Areas Fade Wallplate	36
WALLPLATE LAYOUT.....	8	ENVIRON LINKS WALLPLATES.....	38
SETTING UP STAGE SCENES WALLPLATES	9	EL2- Environ Links 2 Area Wallplate	38
Dipswitch settings	9	EL3- Environ Links 3 Area Wallplate	39
Master switch	10	EL4- Environ Links 4 Area Wallplate	41
Terminating resistor	10	EL6- Environ Links 6 Area Wallplate	42
STAGE SCENES WALLPLATES.....	11	EL8- Environ Links 8 Area Wallplate	44
SC6- Stage Scenes Wallplate	11	TECHNICAL MANUAL	46
SQ6- Stage Cues Wallplate	12	Command structure	46
STAGE SCENES LINKS WALLPLATES.....	15	Communication standard	46
SL2- Stage Links 2 Area Wallplate	15	STAGE SCENE COMMAND CODES.....	47
SL3- Stage Links 3 Area Wallplate	16	Stage Fade to Next Scene	47
SL4- Stage Links 4 Area Wallplate	18	Stage Fade to Previous Scene	47
SL6- Stage Links 6 Area Wallplate	19	Stage Fade to Scene Number	47
SL8- Stage Links 8 Area Wallplate	21	Stage Fade Current Scene Up	48

Stage Fade Current Scene Down	48
Stage Stop Fading Current Scene	48
Stage Master On Command	48
Stage Master Off Command	49
Stage Store Blackout to Current Scene	49
Stage Store DMX+Scene levels to Current Scene	49
Stage Store Full levels to Current Scene	49
Stage Set Area Links	50
Stage Clear Area Links	50
Stage Start Show	50
Stage End Current Show	50
Stage Cue Next in Current Show	51
Stage Cue Back in Current Show	51
Stage Stop (Pause) Current Show	51
Stage Run (Play) Current Show	52
Stage Go to Show Scene number	52
Stage Fade Current Show Down	52
Stage Stop Fading Current Show	52

Stage Codes summary	53
ENVIRON PRESET COMMAND CODES	55
Environ Fade to Black	55
Environ Fade to Preset Number	55
Environ Fade Current Preset Up	56
Environ Fade Current Preset Down	56
Environ Stop Fading Current Preset	56
Environ Master On Command	57
Environ Master Off Command	57
Environ Store Blackout to Current Preset	57
Environ Store DMX+Preset levels to Current Preset	58
Environ Store Full levels to Current Preset	58
Environ Set Area Links	59
Environ Clear Area Links	59
Environ Codes summary	59
SPECIFICATIONS	61
DIMENSIONS	62
GLOSSARY	63

THEATRELIGHT WALLPLATES

The Theatrelight Wallplate is a 6 key intelligent lighting controller for use with Theatrelight Dimmers such as Nebula, Meteor and Quasar where these are fitted with the appropriate software. Communication between Wallplates and Nebula dimmer packs uses Theatrelight's proprietary TLNet communication system.

The Wallplate is designed to be mounted in a standard back box and is available in white or black. It is fitted with 6 push buttons, each key backlit with a blue LED. Other colour LEDs can be supplied to customer specification. Key legend can be engraved and paint filled, or laser etched to customer specification. Wallplates can also be silk-screened in wear resistant epoxy ink for larger order quantities.

WALLPLATE ELECTRONICS

Each Wallplate is run by a low power microprocessor, which scans the keys and pre-set dipswitch settings, drives the LEDs, and transmits the appropriate TLNet commands to the data bus. The microprocessor also receives and interprets TLNet commands sent by other Wall plates or Nebulas such as scene or preset, area, link, and master commands. All commands whether from its own keys or from other Wallplates are stored in flash memory after a short time interval, so that at power-on, each Wallplate wakes up in the state it was in when it was turned off.

POWER SUPPLY

Each Wallplate is powered from the same cable which carries the data. Normal Wallplate power requirements is 12 volts, with a total load of 1.5ma per Wallplate (one LED on). Each Wallplate has its own regulator, allowing reliable operation at supply levels down to 6 volts. The 12 volt supply is sourced from every Nebula connected to the common data cable: each Nebula has a 12 volt, 200 mill-amp constant current source, allowing every Nebula to drive up to 100 Wallplates. If many Nebulas are connected to the same data line, each Nebula contributes current to all the Wallplates on the line—so increasing the number of devices allowable.

COMMUNICATION

The Theatrelight TLNet communication standard uses 9600 baud RS485. This slow speed method is chosen to provide the maximum in reliability and noise resistance over the very long runs of cable used in large buildings and industrial environments. In addition, the data packet is kept as short as short as possible to minimise the possibility of collision. Wallplates and Nebula dimmers use a special half-duplex RS-485 transceiver rated at one tenth normal RS-485 unit load. This means over 400 Wallplates and/or Nebula dimmer packs can be connected to the same data line before loading degrades the driver signal significantly. The transceiver chips also have a high common mode range, a very high input impedance, and low power consumption. The chip features a high internal ESD (ElectroStatic Discharge) tolerance, which is further enhanced by

2 THEATRELIGHT WALLPLATES MANUAL

additional surge arrestors external to the chip. As a guideline, the cable run should be limited to 2 kilometres, and the total number of Wallplates and Nebulas on a single data line to 200 without using data buffers. At the completion of all larger installations the data line should always be inspected with an oscilloscope to confirm that the data signal has good edges and is free of noise and reflections.

CONNECTION AND WIRING

Wallplates are designed to be connected together and to Nebula dimmer packs using CAT 5 cable, the standard cable used for Ethernet wiring. Each Wallplate is fitted with an RJ45 socket, allowing the use of a standard Ethernet crimping tool for fitting an RJ45 plug to the CAT 5 cable. The wiring of all the cable ends to the RJ45 sockets is also exactly as used for a straight-through Ethernet installation as follows:

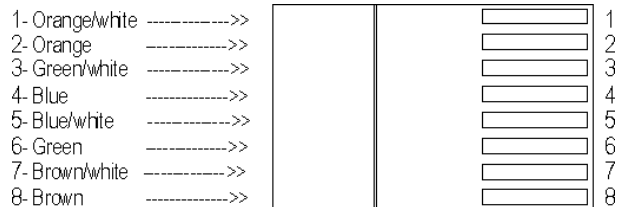

Wallplates must be wired in a continuous daisy chain, starting at the dimmer rack, and looping from Wallplate to Wallplate. The data line must not have any splits, and should preferably be continuous with the fewest possible joins in the line. Short “T” connections of 300mm may be used to connect to each Wallplate. Longer “T” connections should be avoided as they contribute reflections and noise. Keep the data cable at least 600mm away from power and dimmer load cables, preferably in an earthed metal conduit or trunking.

For convenience in initial installation and testing, each Wallplate and Nebula is also fitted with a loop-through RJ45 connector. However the loop-through method of wiring should not be used on any permanent installation as every plug-socket connection contributes a possible failure point. The most reliable method of connection is to solder on a short break-out of length say 300 mm onto the data cable **without cutting or nicking the main data cable**. CAT 5 cable should be subjected to as little flexing as possible during installation. High quality RJ45 connectors should be used to ensure a secure connection for each Wallplate and each Nebula onto the common data line. On long runs, the last Wallplate and Nebula at opposite ends of the data line must be terminated with a 120 ohm resistor to keep reflections and noise to a minimum. The terminating resistor is a link option in all Wallplates.

WALLPLATE SOFTWARE TYPES

Wallplates are available in two major application types: Stage, and Environ, and are designed to operate Nebula (and Meteor and Quasar) dimmer packs fitted with the same software system, via the TLNet communication standard. The major difference between the two systems is that in the Stage software, a dimmer pack can be allocated to just one area out of 8, and can play back just one scene at one fade rate. The Environ software is more complex—every dimmer in a Nebula can be allocated to any one of 16 areas, and each dimmer can play back to a different preset level at that preset's fade rates. In addition, with Environ software each Nebula can be allocated to respond to any one of 16 sectors for a total of 256 sector/areas, making the system ideal for larger architectural and environmental lighting installations.

To summarise: the Stage software is suitable for large and simple lighting systems with a limit of 8 areas such as theatres and stadiums, while the Environ software, with a limit of 256 sector/areas is more suited to lighting of hotels, offices and other buildings. These two systems are described further below.

WALLPLATE CROSSFADES

TIME PROPORTIONAL CROSSFADES

All crossfades in Nebulas whether in Stage or Environ applications use a dipless, time proportional crossfade algorithm. “Dipless” means where levels match on the incoming and outgoing lighting, the dimmer level remains unchanged throughout the fade. “Time proportional crossfade” means that a dimmer programmed to fade from say 40 to 60 percent finishes its fade at exactly the same time as a dimmer moving from 0 to 100%.

CONSTANT SLOPE CROSSFADES

Nebula Show and Chase crossfades in Stage mode software (only) may be set to use an alternative crossfade algorithm. “Constant slope crossfade” means that all dimmers fade at the same rate: a dimmer programmed to fade from 50% to Off percent reaches zero at the same as a dimmer moving from 100% to Off reaches 50%. The constant slope fade is preferable in “comet” chases, or in any sequence of lighting changes where the cues overlap.

REMOTE UP/DOWN FADES

All Nebula Up/Down fades from Wallplate commands whether in Stage or Environ applications use a fixed time, master proportional fade algorithm. When the “Down” key is pressed, the output levels are multiplied proportionally by a master level which is reduced from 100% to zero over 6.5 seconds. When the “Up” key is pressed, the master level is raised from 100% to 200% over 6.5 seconds. This means that current playback levels can be changed within the range from zero to 200% of their original settings. If the Up key is kept pressed, levels originally above 50 % will be limited to 100%. However the true proportional relationship between levels will be restored once the level are taken down again, restoring the original contrast between different lighting sources.

STAGE SCENES SOFTWARE

Stage scenes software adds extra features to the standard Nebula dimmer software in a theatre or display environment. These features are particularly aimed at uses such as

- § Backup scenes in a theatre or any live performance venue
- § Integrated control of foyer lighting, houselights, and working lights in a theatre
- § Simple lighting control of large venues such as Stadium performance lighting
- § Automatic or remote cued shows such as live shows, exhibition displays, window displays etc.

SCENES ATTRIBUTES

Every Nebula fitted with Stage Scenes software has 64 Scenes (each of 3, 6 or 12 dimmer levels according to model). Each scene has the following attributes:

- § An up fade time from Instant to 30 minutes
- § A down fade time from Instant to 30 minutes
- § A fade down delay time from Instant to 30 minutes
- § A wait time of Stop, or 0.1 second to 30 minutes for use with automatic Shows
- § An editable scene label of 8 alpha-numeric characters
- § Local setting of each dimmer level in each scene, including local record from DMX levels, or sourced from a previously copied Scene
- § Instant remote record of Blackout or Full levels, or mixed DMX and Scene levels
- § Each Nebula may be set to respond to one area out a maximum of 8 area commands
- § Dipless crossfade to any scene from 1 to 64 from local pushbutton, or remote matching area command
- § Each Nebula may be allocated a Report Identification number from 1 to 250 for use with Theatrelight Reporting software
- § Continuous readout of all live Scene levels
- § Continuous readout of all remote control data commands

SHOWS AND CHASE ATTRIBUTES

In addition Stage Scene software for Nebulas includes an auto Show facility which uses the 64 scenes as cue states. There are a total of 20 Shows or Chases, each with programmable start and end scenes selected from the 64 recorded scenes with their fade times and levels. The wait time programmed on each scene is the time delay before the next scene is cross-faded in. Synchronised shows and chase across a number of Nebula packs is possible—if the wait time is set to “stop”, the Nebula relies on a command sent by a master Nebula to change its cue. Each show or chase has the following attributes:

- § Programmable start scene
- § Programmable end scene
- § Wait times between cues from 0.1 second to 30 minutes, and Stop
- § An editable label of 8 alphanumeric characters
- § Each of the 20 Shows may be programmed as a Show (an auto-sequence of scenes stopping at the last scene) or as a Chase (an auto-sequence of scenes which restarts after the last scene)
- § Chases can be programmed to be auto-reversing
- § Shows and Chases can be programmed to use time-proportional or constant slope cross-fades
- § Remote start, end, and run/pause control from matching area Wallplate show controllers.

STAGE SCENES CONTROLLERS

Stage Scenes controllers are designed to remotely control Nebula Scene crossfades. The following Stage Scenes wallplates are available

SC6 Functions: 6 crossfade scenes, or 4 crossfade scenes with up/dn fade keys

SQ6 Functions: Cue go and back keys with 4 Scene keys (2 first, 2 last), or with 2 Scene keys (1 first, 1 last) and up/dn fade keys

STAGE LINKS CONTROLLERS

Links controller are designed to be used with the linkable SC6 and SQ6 controllers described above. They give the ability to link multiple areas together for control by single wallplates. The following Stage Scenes Links wallplates are available:

- SL2 Functions:** 5 crossfade scenes each addressing areas 1+2, and 1 Link on/off key, to link/unlink areas 1+2
- SL3 Functions:** 4 crossfade scenes each addressing areas 1+2+3, and 2 Link on/off keys, to link/unlink areas 1+2, and areas 2+3
- SL4 Functions:** 4 fixed area Link on/off keys, to link/unlink areas 1+2, areas 2+3, areas 3+4, areas 4+1 In addition two user definable Link keys link areas pre-set on the 8 way dipswitch
- SL6 Functions:** 5 fixed area Link on/off keys, to link/unlink areas 1+2, areas 2+3, areas 3+4, areas 4+5, and areas 5+6. In addition another user definable Link key links areas pre-set on the 8 way dipswitch
- SL8 Functions:** 5 fixed area Link on/off keys, to link/unlink areas 1+2, areas 3+4, areas 5+6, areas 7+8, and all areas 1 through 8. In addition another user definable Link key links areas pre-set on the 8 way dipswitch

STAGE SHOWS CONTROLLERS

Stage Show controller are designed to remotely control Nebula auto-Show playback. The following Stage Shows wallplates are available

- SH1 Functions:** Show start, Show pause, Cue go and Cue back, Fade down, and Show end
- SH6 Functions:** Show 1 start/end, Show 2 start/end, Show 3 start/end, Show 4 start/end, Show 5 start/end, Show 6 start/end. Key 5 may be alternatively configured as a fade down button, leaving 5 addressable shows

REMOTE CONTROLLED SCENES AND SHOWS

To connect a number of Nebulas together for remote control of Scenes or Shows over a large number of dimmers, each Nebula must be connected to the common TLNet data cable. Then each Nebula must be set up as follows

1. **Each Nebula must be set with Local Scenes (or Shows) and Remote Scenes (or Shows) set On.**
2. **Each Nebula must be set to an Area ID which matches the remote command, whether from other Nebulas, Theatrelight Wallplates, or remote computer.**
3. **Each Scene in each Nebula must be programmed for its correct playback levels and fade times.**
4. **If using Show mode, each Show must programmed for its correct start scene, end scene, and Show/Chase type, and each scene Wait time must be set correctly.**
5. **If using more than one Nebula to run a synchronous Show or Chase, scene wait times on “slave” Nebulas must be set at Stop.**

WALLPLATE LAYOUT

BACK VIEW OF PCB

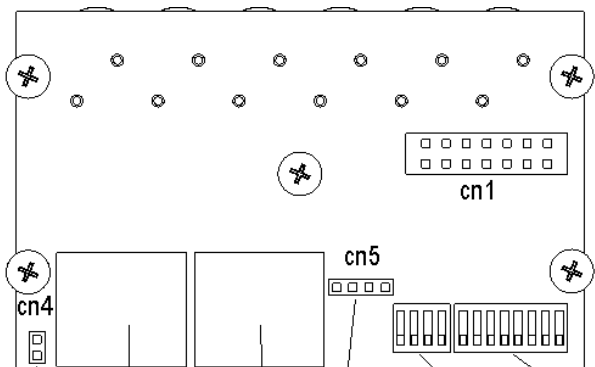

WALLPLATE FRONT VIEW

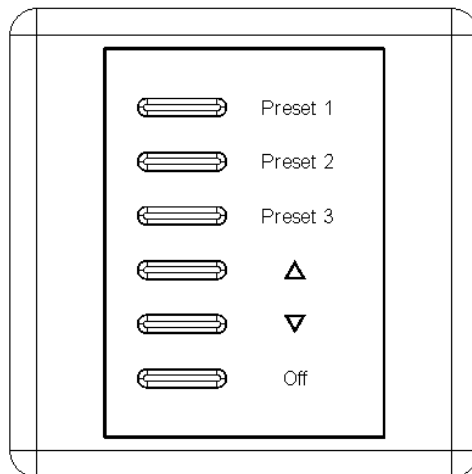

Terminating Resistor

Master Switch

Dipswitch 4

Dipswitch 8

On: Link On
Off: Link Off

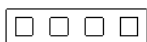

4 3 2 1

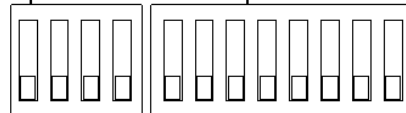

1 2 3 4

1 2 3 4 5 6 7 8

Master On: Connect Pins 3 and 4
Master Off: No connection

Dipswitch Up is On (1)
Dipswitch Down is Off (0)

SETTING UP STAGE SCENES WALLPLATES

On the back of each Wallplate are two dipswitches as shown opposite. These dipswitches may be set by the installer on site to define area and scene numbers, and to define the behaviour of the keys. A typical wallplate setup follows below.

DIPSWITCH SETTINGS

The dipswitch settings define scene number, area number, and links or key behaviour.

As an example, to set up the **SC6** wallplate below, follow the instructions below. In all examples switch **Off** means the switch is set **Down** [binary 0]; switch **On** means the dipswitch is set **Up** [binary 1]:

:

1. **Set Dipswitch 4/bit 1 off if you want a 6 scene controller; set Dipswitch 4/1 on for a 4 scene controller with 2 keys set as Up/Down fade keys.**
2. **Set Dipswitch 4/bits 2, 3, 4 to define the wallplate native area code to a number from 1 to 8—only Nebulas which have been set to match this area number will respond to the wallplate command.**

§ The wallplate native area number uses a binary coded offset—**offset** means the value is **added** to Area 1:

Dipswitch Bit	Dip 4/2	Dip 4/3	Dip 4/4
Area Offset	4	2	1

Some examples of area number settings:

Area 1:	Set dipswitch 4/ bits 2, 3, 4 to [0,0,0]: (area 1 + offset 0)
Area 3:	Set dipswitch 4/ bits 2, 3, 4 to [0,1,0]: (area 1 + offset 2)
Area 8:	Set dipswitch 4/ bits 2, 3, 4 to [1,1,1]: (area 1 + offset 7 = 4+2+1)

3. **Set Dipswitch 8/bit 1 off if you want the wallplate to ignore Area Link commands sent by other controllers; set Dipswitch 8/bit 1 on if you want the wallplate to respond to Area Link commands sent by other controllers.**

§ Area Link commands “join” two (or more) lighting areas together so that they can be controlled from one wallplate. These linked areas are **added accumulatively** to the native wallplate area command if dipswitch 8/bit 1 is set to “Linkable”.

4. **Set Dipswitch 8/bit 2 off if you want the wallplate to always send its own native area code (with or without links); set Dipswitch 8/bit 2 on if you want the wallplate to control all 8 areas.**

10 THEATRELIGHT WALLPLATES MANUAL

§ This option is useful as one wallplate is required to function as master controller over all areas.

5. Set Dipswitch 8/bits 3, 4, 5, 6, 7, 8 to define the wallplate scene start address—Nebulas which match the wallplate area number will fade to the scene number corresponding to the wallplate key.

§ The wallplate native area number uses a binary coded offset—**offset** means the value is **added** to Area 1:

Dipswitch Bit	Dip 8/3	Dip 8/4	Dip 8/5	Dip 8/6	Dip 8/7	Dip 8/7
Scene Offset	32	16	8	4	2	1

Some examples of scene number settings:

Scene 1: Set dipswitch 8/ bits 3, 4, 5, 6, 7, 8 to [0,0,0,0,0,0]: (scene 1 + offset 0)

Scene 13: Set dipswitch 8/ bits 3, 4, 5, 6, 7, 8 to [0,0,1,1,0,0]: (scene 1 + offset 12= 8+4)

Scene 19: Set dipswitch 8/ bits 3, 4, 5, 6, 7, 8 to [0,1,0,0,1,0]: (scene 1 + offset 18= 16+2)

Other Stage Scenes, Shows, and Link key functions, dipswitch options, and key commands are described under each wallplate type below.

MASTER SWITCH

Most Wallplates can be fitted with an external Master take-over key-switch. If set on, the Wallplate issues a command which disables all other matching area Wallplates. All such Wallplate are delivered with a connecting plug with two wires for soldering onto any suitable key operated switch.

TERMINATING RESISTOR

All Wallplates are delivered with a spare link for connecting a terminating resistor. Install this link only if the Wallplate is the last one on the daisy chain.

STAGE SCENES WALLPLATES

The current Stage Scenes Wallplates are as follows:

SC6- STAGE SCENES WALLPLATE

SC6 Key functions: User programmable as 6 crossfade scenes, or as 4 crossfade scenes with up/dn fade keys.

The scenes may be set to any address from 1 to 64, and the area address to a single area from 1 to 8, or to address all 8 areas. When set to a single area, the plate may be set to accept or ignore link commands from link controllers. Other functions include storing mixed DMX and scene levels, or blackout or Full levels to the current scene. The Wallplate also has an input for an external Master take-over switch, which disables all other linked matching area Wallplates.

This controller is ideally suited to houselight and working lights control in a theatre, or house or show lighting in a larger venue.

SC6 Dipswitch settings

4 Way Dipswitch

	Scenes	Scenes Fade Up/Dn
dip4/1	0= No fade up/dn	1= Fade up/dn
dip4/2	Area offset 4	Area offset 4
dip4/3	Area offset 2	Area offset 2
dip4/4	Area offset 1	Area offset 1

8 Way Dipswitch

Dip8/1	0/1=Fixed area/linkable areas	0/1=Fixed area/linkable areas
Dip8/2	0/1= Addressed Area/All Areas	0/1= Addressed Area/All Areas
Dip8/3	Scene offset 32	Scene offset 32
Dip8/4	Scene offset 16	Scene offset 16
Dip8/5	Scene offset 8	Scene offset 8
Dip8/6	Scene offset 4	Scene offset 4
Dip8/7	Scene offset 2	Scene offset 2
Dip8/8	Scene offset 1	Scene offset 1

SC6 Key Actions

Key 1	Scene 1 + offset	Scene 1 + offset
Key 2	Scene 2 + offset	Scene 2 + offset
Key 3	Scene 3 + offset	Scene 3 + offset
Key 4	Scene 4 + offset	Fade up
Key 5	Scene 5 + offset	Fade dn
Key 6	Scene 6 + offset	Scene 4 + offset

SC6 Other Key actions

Store Full levels to current scene	Hold Key 6, press Key 1, wait for LEDs flash (3 secs)
Store DMX + Scenes levels to current scene	Hold Key 6, press Key 2, wait for LEDs flash (3 secs)
Store Blackout to current scene	Hold Key 6, press Key 3, wait for LEDs flash (3 secs)
Master On/Off (via external key switch)	0>1 = Master On, 1>0 = Master Off

SC6 LED Behaviour

Scene LED on	Current Scene matches this wallplate scene address
Scene LED blink	Current Scene does not match this wallplate scene address
All LEDs blink once every 2 secs	Keys disabled (another matching area wallplate is Master)

SQ6- STAGE CUES WALLPLATE

SQ6 Key functions: Cue go and Cue back keys with 4 Scene keys (2 first, 2 last), or with 2 Scene keys (1 first, 1 last) and up/dn fade keys.

The last scenes may be set to any address up to 64, and the area address to a single area from 1 to 8, or to all 8 areas. When set to a single area, the plate may be set to accept or ignore link commands from other plates. Other function include store mixed DMX and scene levels, or blackout or Full levels to the current scene. The Wallplate also has an input for an external Master take-over switch, which disables all other matching area Wallplates.

This controller is suited to manually or computer cued operation of shows such as concerts or stadium lighting limited to 64 lighting changes.

SQ6 Dipswitch settings**4 Way Dipswitch**

dip4/1

Cues

Cues Fade Up/Dn

0= No fade up/dn

1= Fade up/dn

dip4/2

Area offset 4

Area offset 4

dip4/3

Area offset 2

Area offset 2

dip4/4

Area offset 1

Area offset 1

8 Way Dipswitch

Dip8/1

0/1=Fixed area/linkable areas

0/1=Fixed area/linkable areas

Dip8/2

0/1= Addressed Area/All Areas

0/1= Addressed Area/All Areas

Dip8/3

Last Scene offset 32

Last Scene offset 32

Dip8/4

Last Scene offset 16

Last Scene offset 16

Dip8/5

Last Scene offset 8

Last Scene offset 8

Dip8/6

Last Scene offset 4

Last Scene offset 4

Dip8/7

Last Scene offset 2

Last Scene offset 2

Dip8/8

Last Scene offset 1

Last Scene offset 1

SQ6 Key Actions

Key 1

Cue Go

Cue Go

Key 2

Cue Back

Cue Back

Key 3

Scene 1

Scene 1

Key 4

Scene 2

Fade up

Key 5

Last scene -1+ offset

Fade dn

Key 6

Last scene + offset

Last scene + offset

SQ6 Other Key actions

Store Full levels to current scene

Hold Key 6, press Key 1, wait for LEDs flash (3 secs)

Store DMX + Scenes levels to current scene

Hold Key 6, press Key 2, wait for LEDs flash (3 secs)

14 THEATRELIGHT WALLPLATES MANUAL

Store Blackout to current scene

Hold Key 6, press Key 3, wait for LEDs flash (3 secs)

Master On/Off (via external key-switch)

0>1= Master On, 1>0 = Master Off

SQ6 LED Behaviour

Scene LED on

Current Scene matches this wallplate scene address

Scene LED blink

Current Scene does not match this wallplate scene address

All LEDs blink once every 2 secs

Keys disabled (another matching area wallplate is Master)

STAGE SCENES LINKS WALLPLATES

The Stage Scenes Links controllers are designed to be used with the linkable SC6 and SQ6 controllers described above. They give the ability to link multiple areas together for control by single wallplates. Links controllers allow individual or linked control of multiple areas such as theatre house-lights or stadium lighting.

SL2- STAGE LINKS 2 AREA WALLPLATE

SL2 Key functions: 5 crossfade scenes each addressing areas 1+2, and 1 Link on/off key, to link/unlink areas 1+2

The scenes may be set to any address from 1 to 64, and the area address to 1 to 8. The plate may be set to accept or ignore link commands from other similar plates. The Wallplate also has an input for an external Master take-over switch, which disables all other matching area Wallplates.

This controller and other Scenes links controllers below are designed to be used with the SC6 and SQ6 controllers above. They are suited to the linked control of houselights, foyer lighting and other applications.

SL2 Dipswitch settings

4 Way Dipswitch

dip4/1	x
dip4/2	Area offset 4
dip4/3	Area offset 2
dip4/4	Area offset 1

8 Way Dipswitch

Dip8/1	x
Dip8/2	x
Dip8/3	Scene offset 32
Dip8/4	Scene offset 16
Dip8/5	Scene offset 8
Dip8/6	Scene offset 4
Dip8/7	Scene offset 2

16 THEATRELIGHT WALLPLATES MANUAL

Dip8/8

Scene offset 1

SL2 Key Actions

Key 1

Scene 1+ offset, Areas 1, 2+ offset

Key 2

Scene 2+ offset, Areas 1, 2+ offset

Key 3

Scene 3+ offset, Areas 1, 2+ offset

Key 4

Scene 4+ offset, Areas 1, 2+ offset

Key 5

Scene 5+ offset, Areas 1, 2+ offset

Key 6

Link/Unlink Areas 1, 2+ offset

SL2 Other Key actions

Master On/Off (via external key-switch) 0>1= Master On, 1>0 = Master Off

SL2 Action Of Link Keys

Pressing “Off” link keys links areas additively

Pressing any “On” link key unlinks all areas

SL2 LED Behaviour

Scene LED on

Current Scene matches this wallplate scene address

Scene LED blink

Current Scene does not match this wallplate scene address

Link LED on/off

Area Link on/off

All LEDs blink once every 2 secs

Keys disabled (another matching area wallplate is Master)

SL3- STAGE LINKS 3 AREA WALLPLATE

SL3 Key functions: 4 crossfade scenes each addressing areas 1+2+3, and 2 Link on/off keys, to link/unlink areas 1+2, and areas 2+3.

The scenes may be set to any address from 1 to 64, and the area address from to 1 to 8. The plate may be set to accept or ignore link commands from other similar plates. The Wallplate also has an input for an external Master take-over switch, which disables all other matching area Wallplates. This controller is designed to be used with the SC6 and SQ6 controllers above.

SL3 Dipswitch settings**4 Way Dipswitch**

dip4/1	x
dip4/2	Area offset 4
dip4/3	Area offset 2
dip4/4	Area offset 1

8 Way Dipswitch

Dip8/1	x
Dip8/2	x
Dip8/3	Scene offset 32
Dip8/4	Scene offset 16
Dip8/5	Scene offset 8
Dip8/6	Scene offset 4
Dip8/7	Scene offset 2
Dip8/8	Scene offset 1

SL3 Key Actions

Key 1	Scene 1+ offset, Areas 1, 2, 3 + offset
Key 2	Scene 2+ offset, Areas 1, 2, 3 + offset
Key 3	Scene 3+ offset, Areas 1, 2, 3 + offset
Key 4	Scene 4+ offset, Areas 1, 2, 3 + offset
Key 5	Link Areas 1, 2 + offset
Key 6	Link Areas 2, 3 + offset

SL3 Other Key actions

Master On/Off (via external key-switch) 0>1= Master On, 1>0 = Master Off

SL3 Action Of Link Keys

Pressing “Off” link keys links areas additively

Pressing any “On” link key unlinks all areas

SL3 LED Behaviour

Scene LED on	Current Scene matches this wallplate scene address
Scene LED blink	Current Scene does not match this wallplate scene address
Link LED on/off	Area Link on/off
All LEDs blink once every 2 secs	Keys disabled (another matching area wallplate is Master)

SL4- STAGE LINKS 4 AREA WALLPLATE

SL4 Key functions: 4 fixed area Link on/off keys, to link/unlink areas 1+2, areas 2+3, areas 3+4, areas 4+1. In addition two user definable Link keys link areas pre-set on the 8 way dipswitch.

The area address may be set from to 1 to 8. The Wallplate also has an input for an external Master take-over switch, which disables all other matching area Wallplates. This controller is designed to be used with the SC6 and SQ6 controllers above.

SL4 Dipswitch settings

4 Way Dipswitch

dip4/1	x
dip4/2	Area offset 4
dip4/3	Area offset 2
dip4/4	Area offset 1

8 Way Dipswitch

Dip8/1	Area 4+ offset
Dip8/2	Area 3+ offset
Dip8/3	Area 2+ offset
Dip8/4	Area 1+ offset
Dip8/5	Area 4+ offset

Dip8/6	Area 3+ offset
Dip8/7	Area 2+ offset
Dip8/8	Area 1+ offset

SL4 Key Actions

Key 1	Link Areas 1, 2 + offset
Key 2	Link Areas 2, 3 + offset
Key 3	Link Areas 3, 4 + offset
Key 4	Link Areas 4, 1 + offset
Key 5	Link Areas set on dipswitch 8, switches 1-4
Key 6	Link Areas set on dipswitch 8, switches 5-8

SL4 Other Key actions

Master On/Off (via external key-switch) 0>1 = Master On, 1>0 = Master Off

SL4 Action Of Link Keys

Pressing "Off" link keys links areas additively

Pressing any "On" link key unlinks all areas

SL4 LED Behaviour

Link LED on/off	Area Link on/off
All LEDs blink once every 2 secs	Keys disabled (another matching area wallplate is Master)

SL6- STAGE LINKS 6 AREA WALLPLATE

SL6 Key functions: 5 fixed area Link on/off keys, to link/unlink areas 1+2, areas 2+3, areas 3+4, areas 4+5, and areas 5+6. In addition another user definable Link key links areas pre-set on the 8 way dipswitch.

The area address may be set from to 1 to 8. The Wallplate also has an input for an external Master take-over switch, which disables all other matching area Wallplates. This controller is designed to be used with the SC6 and SQ6 controllers above.

SL6 Dipswitch settings

4 Way Dipswitch

dip4/1	x
dip4/2	x
dip4/3	Area offset 2
dip4/4	Area offset 1

8 Way Dipswitch

Dip8/1	x
Dip8/2	x
Dip8/3	Area 6+ offset
Dip8/4	Area 5+ offset
Dip8/5	Area 4+ offset
Dip8/6	Area 3+ offset
Dip8/7	Area 2+ offset
Dip8/8	Area 1+ offset

SL6 Key Actions

Key 1	Link Areas 1, 2 + offset
Key 2	Link Areas 2, 3 + offset
Key 3	Link Areas 3, 4 + offset
Key 4	Link Areas 4, 5 + offset
Key 5	Link Areas 5, 6 + offset
Key 6	Link Areas set on dipswitch 8, switches 1-6

SL6 Other Key actions

Master On/Off (via external key-switch) 0>1 = Master On, 1>0 = Master Off

SL6 Action Of Link Keys

Pressing “Off” link keys links areas additively

Pressing any “On” link key unlinks all areas

SL6 LED Behaviour

Link LED on/off

Area Link on/off

All LEDs blink once every 2 secs

Keys disabled (another matching area wallplate is Master)

SL8- STAGE LINKS 8 AREA WALLPLATE

SL8 Key functions: 5 fixed area Link on/off keys, to link/unlink areas 1+2, areas 3+4, areas 5+6, areas 7+8, and all areas 1 through 8. In addition another user definable Link key links areas pre-set on the 8 way dipswitch.

The area address may be set from 1 to 8. The Wallplate also has an input for an external Master take-over switch, which disables all other matching area Wallplates. This controller is designed to be used with the SC6 and SQ6 controllers above.

SL8 Dipswitch settings**4 Way Dipswitch**

Dip4/1 x

Dip4/2 x

Dip4/3 x

Dip4/4 x

8 Way Dipswitch

Dip8/1 Area 8

Dip8/2 Area 7

Dip8/3 Area 6

Dip8/4 Area 5

Dip8/5 Area 4

Dip8/6 Area 3

22 THEATRELIGHT WALLPLATES MANUAL

Dip8/7 Area 2

Dip8/8 Area 1

SL8 Key Actions

Key 1 Link Areas 1, 2

Key 2 Link Areas 3, 4

Key 3 Link Areas 5, 6

Key 4 Link Areas 7, 8

Key 5 Link All Areas 1 through 8

Key 6 Link Areas set on dipswitch 8, switches 1-8

SL8 Other Key actions

Master On/Off (via external key-switch) 0>1 = Master On, 1>0 = Master Off

SL8 Action Of Link Keys

Pressing "Off" link keys links areas additively

Pressing any "On" link key unlinks all areas

SL8 LED Behaviour

Link LED on/off Area Link on/off

All LEDs blink once every 2 secs Keys disabled (another matching area wallplate is Master)

STAGE SHOWS WALLPLATES

These Wallplates are for use with Stage mode Nebulas with Show mode enabled. All Wallplates feature 6 backlit keys, while on the back of the unit are two dipswitches. See above under “Setting Up Stage Scenes Wallplates” for help on setting up the dipswitches. The SH1 and SH6 controllers are not area-linkable, but the all-areas dipswitch setting enables the operator to start a synchronised show in all areas at once if required.

SH1- STAGE SINGLE SHOW WALLPLATE

SH1 Key functions: Show start, Show pause, Cue go and Cue back, Fade down, and Show end.

The Show address may be set to any address up to 1 to 20, with the area address to a single area from 1 to 8, or to all areas 1-8. Other functions include store mixed DMX and scene levels, or blackout or Full levels to the current scene of the show. The Wallplate also has an input for an external Master take-over switch, which disables all other matching area Wallplates. This controller is suited to auto-timed one shot or repetitive shows and chases ideal for exhibitions, window displays and other automatic light displays.

SH1 Dipswitch settings

4 Way Dipswitch

dip4/1	x
dip4/2	Area offset 4
dip4/3	Area offset 2
dip4/4	Area offset 1

8 Way Dipswitch

Dip8/1	x
Dip8/2	0/1= Addressed Area/All Areas
Dip8/3	x
Dip8/4	Show offset 16
Dip8/5	Show offset 8
Dip8/6	Show offset 4
Dip8/7	Show offset 2
Dip8/8	Show offset 1

SH1 Key Actions

Key 1	Show 1 + offset Start
Key 2	Show Run on/off
Key 3	Cue forward
Key 4	Cue back
Key 5	Fade down
Key 6	Show End

SH1 Other Key actions

Store Full levels to Show scene	Hold Key 6, press Key 1, wait for LEDs flash (3 secs)
Store DMX + Scenes levels to Show scene	Hold Key 6, press Key 2, wait for LEDs flash (3 secs)
Store Blackout to Show scene	Hold Key 6, press Key 3, wait for LEDs flash (3 secs)
Master On/Off (via external key-switch)	0>1= Master On, 1>0 = Master Off

SH1 LED Behaviour

Show LED on	Current Show matches this wallplate show address
LED 6 blink	Current Show does not match this wallplate show address
Run LED on	Current Show running
End LED on	Current Show ended
All LEDs blink once every 2 secs	Keys disabled (another matching area wallplate is Master)

SH6- STAGE SHOWS WALLPLATE

SH6 Key functions: Show 1 start/end, Show 2 start/end, Show 3 start/end, Show 4 start/end, Show 5 start/end, Show 6 start/end. Key 5 may be alternatively configured as a fade down button, leaving 5 addressable shows.

The Show address may be set to any address up to 20, with the area address to a single area from 1 to 8, or to all areas 1-8. Other function include store mixed DMX and scene levels, or blackout or Full levels to the current scene of the show. The Wallplate also has an input for an external Master take-over switch, which disables all other matching area Wallplates.

This controller is suited to auto-timed one shot or repetitive shows and chases ideal for exhibitions, window displays and other automatic light displays, where more than one automatic timed show is required. Another use is as a controller to select 6 automated faded sequences (up or down fades) for multistage dimming of house lights in cinemas, concert halls and theatres.

SH6 Dipswitch settings

4 Way Dipswitch

dip4/1	x
dip4/2	Area offset 4
dip4/3	Area offset 2
dip4/4	Area offset 1

8 Way Dipswitch

Dip8/1	x
Dip8/2	0/1= Addressed Area/All Areas
Dip8/3	0/1= Shows Stop/End
Dip8/4	0/1= Key 5: Show 5/Fade dn
Dip8/5	Show offset 8
Dip8/6	Show offset 4
Dip8/7	Show offset 2
Dip8/8	Show offset 1

SH6 Key Actions

Key 1	Show 1 + offset Start/(stop/end)
Key 2	Show 2 + offset Start/(stop/end)
Key 3	Show 3 + offset Start/(stop/end)
Key 4	Show 4 + offset Start/(stop/end)
Key 5	Show 5 + offset Start/(stop/end) / Fade dn
Key 6	Show 6/5 if fade + offset Start/(stop/end)

SH6 Other Key actions

Store Full levels to Show scene:	Hold Key 6, press Key 1, wait for LEDs flash (3 secs)
Store DMX + Scenes levels to Show scene:	Hold Key 6, press Key 2, wait for LEDs flash (3 secs)
Store Blackout to Show scene:	Hold Key 6, press Key 3, wait for LEDs flash (3 secs)
Master On/Off (via external key-switch):	0>1= Master On, 1>0 = Master Off

SH6 LED Behaviour

Show LED on	Current Show running
LED 6 blink	Current Show does not match this wallplate show address
All LEDs blink once every 2 secs	Keys disabled (another matching area wallplate is Master)

ENVIRON SOFTWARE

The Environ software is designed so the Nebula may be used as a environmental light controller in hotels, building foyers, showrooms, restaurants and other public areas, and as an integrated lighting control in larger buildings and office blocks. In such venues, dimmers need to be programmed to light particular **areas** with a number of different level setting or **presets**. Frequently the areas need to **linked** together so that a number of areas can be controlled at the same time from just one wallplate or other controller. Additionally in larger venues, a **sector**—a group of lighting areas such as all the areas in a multifunction room—requires to be controlled separately from other sectors. Environ software allows each Nebula dimmer to be set to any one of 64 preset levels in any one of 16 areas, while each Nebula dimmer pack can set to any one of 16 sectors. Link commands from wallplates enable linking of any of up to 16 areas for overall control by a single wallplate

PRESETS ATTRIBUTES

Every Nebula fitted with Environ software has the following capabilities:

- § 64 Presets (each of 3, 6 or 12 dimmer levels according to model)
- § Each preset has the following attributes
- § Up, Down, and Delay fade times from Instant to 30 minutes
- § An editable label of 8 alphanumeric characters
- § Local setting of each dimmer level in each preset, including local record from DMX levels, or levels sourced from a previously copied Preset
- § Instant remote record of Blackout or Full levels, or mixed DMX and Preset levels
- § Each dimmer in a Nebula may be set to respond to one area out a maximum of 16 area commands
- § Each dimmer in a Nebula may given a name of 8 alphanumeric characters
- § Each area in a Nebula may given a name of 8 alphanumeric characters
- § Each Nebula may be set to respond to one sector out a maximum of 16 sector commands—a total of 256 sector/areas
- § Dipless crossfades of matching sector/area dimmers to any preset from 1 to 64 from local pushbutton or remote sector/area command. Mid-scale fade resolution is 4 microseconds (>11 bit) for smooth fades
- § Each Nebula may be given a Report Identification number from 1 to 250
- § Continuous readout of all live Preset levels, and all remote control data commands

ENVIRON PRESETS CONTROLLERS

The following Environ Presets wallplates and their functions are available

- EP6 Functions:** 6 crossfade Presets (linkable)
- EPF4 Functions:** 4 crossfade Presets, with up/dn fade keys (linkable)
- EA6 Functions:** 6 fade on/off Areas
- EAF4 Functions:** 4 fade on/off Areas, with up/dn fade keys

ENVIRON LINKS CONTROLLERS

The Environ links controller are designed to be used with the linkable EP6 and EPF4 controllers described above. They give the ability to link multiple areas together for control by single wallplates or other controllers.

- EL2 Functions:** 5 crossfade Presets each addressing areas 1+2, and 1 Link on/off key, to link/unlink areas 1+2
- EL3 Functions:** 4 crossfade Presets addressing areas 1+2+3, and 2 Link on/off keys, to link/unlink areas 1+2, and 2+3
- EL4 Functions:** 4 fixed area Link on/off keys, to link/unlink areas 1+2, areas 2+3, areas 3+4, and areas 4+1. In addition 2 user definable Link keys link areas pre-set on the 8 way dipswitch
- EL6 Functions:** 5 fixed area Link on/off keys, to link/unlink areas 1+2, areas 2+3, areas 3+4, areas 4+5, and areas 5+6. In addition another user definable Link key links areas pre-set on the 8 way dipswitch
- EL8 Functions:** 5 fixed area Link on/off keys, to link/unlink areas 1+2, areas 3+4, areas 5+6, areas 7+8, and all areas 1 through 8. In addition another user definable Link key links areas pre-set on the 8 way dipswitch

REMOTE CONTROLLED PRESETS

To connect a number of Nebulas together for remote control of Presets over a large number of dimmers, each Nebula must be connected to the common TLNet data cable. Then each Nebula must be set up as follows

1. **Each Nebula must be set with Local Presets and Remote Presets On.**
2. **Each dimmer in the Nebula must be set to an Area ID which matches the remote command, whether from other Nebulas, Theatrelight Wallplates, or remote computer.**
3. **Each Nebula dimmer pack must be set to a Sector ID which matches the remote command, whether from other Nebulas, Theatrelight Wallplates, or remote computer.**
4. **Each preset in each Nebula must be programmed for its correct playback levels and fade times.**

SETTING UP ENVIRON PRESETS WALLPLATES

Environ Wallplates have the same electronics as the Stage Scenes Wallplates above, but have different firmware and behaviour. All Wallplates feature 6 backlit keys, while on the back of the unit are two dipswitches. The dipswitches may be set by the installer on site to define area and preset numbers, and to define the behaviour of the keys. A typical wallplate setup follows below (refer to the drawings on Page 8 for dipswitch layout):

DIPSWITCH SETTINGS

Each Wallplate controller is configurable using the 2 PCB mounted dipswitches. The dipswitch settings define preset number, area number, and links or key behaviour. In all Environ wallplates, the sector code (“A” to “P” for sectors 1 to 16) is encoded in firmware, and normally supplied as Sector “A”. Wallplates may be specified with any sector code at time of order.

As an example, to set up the EP6 wallplate below, follow the instructions below. In all examples switch **Off** means the switch is set **Down** [binary 0]; switch **On** means the dipswitch is set **Up** [binary 1] ::

1. **Set Dipswitch 4/bits 1, 2, 3, 4 to define the wallplate native area code to a number from 1 to 16—only Nebula dimmers which have been set to match this area number will respond to the wallplate command.**

§ The wallplate area number uses a binary code offset—**offset** means the binary dipswitch setting is **added** to Area 1:

Dipswitch Bit	Dip 4/1	Dip 4/2	Dip 4/3	Dip 4/4
Area Offset	8	4	2	1

Some examples of area number settings follow:

- Area 1: Set dipswitch 4/ bits 1, 2, 3, 4 to [0,0,0,0]: (area 1 + offset 0)
- Area 3: Set dipswitch 4/ bits 1, 2, 3, 4 to [0,0,1,0]: (area 1 + offset 2)
- Area 10: Set dipswitch 4/ bits 1, 2, 3, 4 to [1,0,0,1]: (area 1 + offset 9 = 8+1)

Note that the Sector code sent by the Wallplate must also match the sector code on each Nebula for the command to be recognised.

2. **Set Dipswitch 8/bit 1 off if you want the wallplate to ignore Area Link commands sent by other controllers ; set Dipswitch 8/bit 1 on if you want the wallplate to respond to Area Link commands sent by other controllers.**

30 THEATRELIGHT WALLPLATES MANUAL

§ Area Link commands “join” two or lighting areas together so that they can be controlled from one wallplate. These linked areas are **added accumulatively** to the native wallplate area command if dipswitch 8/1 is set to “Linkable”.

3. Set Dipswitch 8/bit 2 off if you want the wallplate to always send its own native area code (with or without links); set Dipswitch 8/bit 2 on if you want the wallplate to send to all 16 areas.

§ This option is useful as master area controller.

4. Set Dipswitch 8/bits 3, 4, 5, 6, 7, 8 to define the wallplate preset start address—Nebula dimmers which match the wallplate area number will fade to the preset number corresponding to the wallplate key.

§ The wallplate preset number uses a binary code offset—**offset** means the binary dipswitch setting is **added** to Area 1:

Dipswitch Bit	Dip 8/3	Dip 8/4	Dip 8/5	Dip 8/6	Dip 8/7	Dip 8/7
Preset Offset	32	16	8	4	2	1

Some examples of preset number settings follow:

Preset 1 setting: Set dipswitch 8/ bits 3, 4, 5, 6, 7, 8 to [0,0,0,0,0,0]: (preset 1 + offset 0)

Preset 7 setting: Set dipswitch 8/ bits 3, 4, 5, 6, 7, 8 to [0,0,0,1,1,0]: (preset 1 + offset 6= 4+2)

Preset 19 setting: Set dipswitch 8/ bits 3, 4, 5, 6, 7, 8 to [0,1,0,0,1,0]: (preset 1 + offset 18= 16+2)

§ Other Environ key functions, dipswitch options, and key commands are described under each wallplate type below.

MASTER SWITCH

Most Wallplates can be fitted with an external Master take-over key-switch. If set on, the Wallplate issues a command which disables all other matching area Wallplates. All such Wallplate are delivered with a connecting plug with two wires for soldering onto any suitable key operated switch.

TERMINATING RESISTOR

All Wallplates are delivered with a spare link for connecting a terminating resistor. Install this link only if the Wallplate is the last one on the daisy chain.

ENVIRON PRESETS WALLPLATES

In all Environ Presets wallplates, the sector number is encoded in firmware, and normally supplied as Sector 1. Different sector numbers may be specified at time of order. The current Environ Presets Wallplates are as follows:

EP6- ENVIRON PRESETS WALLPLATE

EP6 Key functions: 6 crossfade Presets.

The Presets may be set to any address from 1 to 64, and the area address to a single area from 1 to 16, or to all 16 areas. When set to a single area, the plate may be set to accept or ignore link commands from other plates. Other functions include store mixed DMX and preset levels, or blackout or Full levels to the current area matching preset. The Wallplate also has an input for an external Master take-over switch, which disables all other matching area Wallplates.

This controller is ideally suited to hotel foyers, multifunction rooms, and other public entertainment areas, particularly those with room dividers.

EP6 Dipswitch settings

4 Way Dipswitch

Dip4/1	Area offset 8
Dip4/2	Area offset 4
Dip4/3	Area offset 2
Dip4/4	Area offset 1

8 Way Dipswitch

Dip8/1	0/1=Fixed area/linkable areas
Dip8/2	0/1= Addressed Area/All Areas
Dip8/3	Preset offset 32
Dip8/4	Preset offset 16
Dip8/5	Preset offset 8
Dip8/6	Preset offset 4
Dip8/7	Preset offset 2

32 THEATRELIGHT WALLPLATES MANUAL

Dip8/8 Preset offset 1

EP6 Key Actions

Key 1	Preset 1 + offset
Key 2	Preset 2 + offset
Key 3	Preset 3 + offset
Key 4	Preset 4 + offset
Key 5	Preset 5 + offset
Key 6	Preset 6 + offset

EP6 Other Key actions

Store Full levels to current Preset	Hold Key 6, press Key 1, wait for LEDs flash (3 secs)
Store DMX+Preset levels to current Preset	Hold Key 6, press Key 2, wait for LEDs flash (3 secs)
Store Blackout to current Preset	Hold Key 6, press Key 3, wait for LEDs flash (3 secs)
Master On/Off (via external key-switch)	0>1 = Master On, 1>0 = Master Off

EP6 LED Behaviour

Preset LED on	Current Preset matches this wallplate preset address
Preset LED blink	Current Preset does not match this wallplate preset address
All LEDs blink once every 2 secs	Keys disabled (another matching area wallplate is Master)

EPF4- ENVIRON PRESETS FADE WALLPLATE

EPF4 Key functions: 4 crossfade Presets, with up/dn fade keys

The Presets may be set to any address from 1 to 64, and the area address to a single area from 1 to 16, or to all 16 areas. When set to a single area, the plate may be set to accept or ignore link commands from other plates. Other functions include store mixed DMX and preset levels, or blackout or Full levels to the current matching preset. The Wallplate also has an input for an external Master take-over switch, which disables all other matching area Wallplates.

This controller is suited to clubs, bars, and restaurants and other public entertainment areas, where the ability to adjust the current lighting is required.

EPF4 Dipswitch settings**4 Way Dipswitch**

Dip4/1	Area offset 8
Dip4/2	Area offset 4
Dip4/3	Area offset 2
Dip4/4	Area offset 1

8 Way Dipswitch

Dip8/1	0/1=Fixed area/linkable areas
Dip8/2	0/1= Addressed Area/All Areas
Dip8/3	Preset offset 32
Dip8/4	Preset offset 16
Dip8/5	Preset offset 8
Dip8/6	Preset offset 4
Dip8/7	Preset offset 2
Dip8/8	Preset offset 1

EPF4 Key Actions

Key 1	Preset 1 + offset
Key 2	Preset 2 + offset
Key 3	Preset 3 + offset
Key 4	Fade up
Key 5	Fade dn
Key 6	Preset 4 + offset

EPF4 Other Key actions

Store Full levels to current Preset	Hold Key 6, press Key 1, wait for LEDs flash (3 secs)
Store DMX+Preset levels to current Preset	Hold Key 6, press Key 2, wait for LEDs flash (3 secs)

34 THEATRELIGHT WALLPLATES MANUAL

Store Blackout to current Preset

Hold Key 6, press Key 3, wait for LEDs flash (3 secs)

Master On/Off (via external key-switch)

0>1 = Master On, 1>0 = Master Off

EPF4 LED Behaviour

Preset LED on

Current Preset matches this wallplate preset address

Preset LED blink

Current Preset does not match this wallplate preset address

All LEDs blink once every 2 secs

Keys disabled (another matching area wallplate is Master)

EA6- ENVIRON AREAS WALLPLATE

EA6 Key functions: 6 on/off Areas.

This controller is different in that it can set up 6 different areas to the same preset, rather than the two controllers above which set 6 different presets to the same area. Each key addresses a different area starting from 1 with a maximum of 16, with an on/off fade function on each key. The Preset may be set to any address from 1 to 64. Key 6 also may be set as overall on/of function, fading on or off all the 5 areas addressed by the controller. In addition, to take advantage of the different fade rates offered by different Presets, the keys may be optionally set to different presets. Other functions include store DMX levels, mixed DMX and preset levels, or blackout to the current matching preset. The Wallplate also has an input for an external Master take-over switch, which disables all other matching area Wallplates.

This controller is suited to larger private homes, restaurants, bars or any interior which requires separate on/off fade function in different areas from one Wallplate. This controller is not linkable

EA6 Dipswitch settings

4 Way Dipswitch

Dip4/1

Area offset 8

Dip4/2

Area offset 4

Dip4/3

Area offset 2

Dip4/4

Area offset 1

8 Way Dipswitch

Dip8/1

0= All Areas 1-6 go to Preset 1 levels, 1= Areas 1-5/6 go to Presets 1-5/6 levels

Dip8/2

0= Key 6 normal, 1= Key 6=All areas 1-5 On/Off

Dip8/3	Preset offset 32
Dip8/4	Preset offset 16
Dip8/5	Preset offset 8
Dip8/6	Preset offset 4
Dip8/7	Preset offset 2
Dip8/8	Preset offset 1

EA6 Key Actions

Key 1	Area 1+ fade On to Preset 1 + offset, Off
Key 2	Area 2+ fade On to Preset 1/2 + offset, Off
Key 3	Area 3+ fade On to Preset 1/3 + offset, Off
Key 4	Area 4+ fade On to Preset 1/4 + offset, Off
Key 5	Area 5+ fade On to Preset 1/5 + offset, Off
Key 6	Area 6+ fade On to Preset 1/6 + offset, Off or All On-Off

EA6 Other Key actions

Store Full levels to current Preset	Hold Key 6, press Key 1, wait for LEDs flash (3 secs)
Store DMX+Preset levels to current Preset	Hold Key 6, press Key 2, wait for LEDs flash (3 secs)
Store Blackout to current Preset	Hold Key 6, press Key 3, wait for LEDs flash (3 secs)
Master On/Off (via external key-switch)	0>1 = Master On, 1>0 = Master Off

EA6 Dipswitch options

If Dip8/1 is not set, all areas fade to the same preset, so all fades happen at the same rate. If Dip8/1 is set, preset addresses increment with key number, allowing the user to set a different fade time for each area.

If Dip8/2 is not set, each key turns its own area on and off. If Dip8/2 is set, key 6 turns all keys 1-5 on and off.

EA6 LED Behaviour

Area LED on	Area/Preset selected on
LED 6 blink	No Area/Preset selected on
All LEDs blink once every 2 secs	Keys disabled (another matching area wallplate is Master)

EA4- ENVIRON AREAS FADE WALLPLATE**EA4 Key functions: 4 on/off Areas, with up/dn fade keys.**

This controller is similar to the EA6 above except that 2 of the keys are devoted to an up/down fade function.

EA4 Dipswitch settings**4 Way Dipswitch**

Dip4/1	Area offset 8
Dip4/2	Area offset 4
Dip4/3	Area offset 2
Dip4/4	Area offset 1

8 Way Dipswitch

Dip8/1	0= All Areas Preset 1, 1= Areas 1-3/4>Preset 1-3/4
Dip8/2	0= Key 6 normal, 1= Key 6=All areas 1-3 On/Off
Dip8/3	Preset offset 32
Dip8/4	Preset offset 16
Dip8/5	Preset offset 8
Dip8/6	Preset offset 4
Dip8/7	Preset offset 2
Dip8/8	Preset offset 1

EA4 Key Actions

Key 1	Area 1+ fade On to Preset 1 + offset, Off
Key 2	Area 2+ fade On to Preset 1/2 + offset, Off
Key 3	Area 3+ fade On to Preset 1/3 + offset, Off
Key 4	Fade Up
Key 5	Fade Down

Key 6

Area 4+ fade On to Preset 1/4 + offset, Off or All On-Off

EAF4 Other Key actions

Store Full levels to current Preset

Hold Key 6, press Key 1, wait for LEDs flash (3 secs)

Store DMX+Preset levels to current Preset

Hold Key 6, press Key 2, wait for LEDs flash (3 secs)

Store Blackout to current Preset

Hold Key 6, press Key 3, wait for LEDs flash (3 secs)

Master On/Off (via external key-switch)

0>1 = Master On, 1>0 = Master Off

EAF4 Dipswitch options

If Dip8/1 is not set, all areas fade to the same preset, so all fades happen at the same rate. If Dip8/1 is set, preset addresses increment with key number, allowing the user to set a different fade time for each area.

If Dip8/2 is not set, each key turns its own area on and off. If Dip8/2 is set, key 6 turns all keys 1-3 on and off.

EAF4 LED Behaviour

Area LED on

Area/Preset selected on

LED 6 blink

No Area/Preset selected on

All LEDs blink once every 2 secs

Keys disabled (another matching area wallplate is Master)

ENVIRON LINKS WALLPLATES

The Environ links controller are designed to be used with the linkable EP6 and EPF4 controllers described above. They give the ability to link multiple areas together for control by single wallplates. Links controllers are essential for venues such as multifunction rooms with sliding dividers and hotel foyers. In all Environ Links wallplates, the sector number is encoded in firmware, and normally supplied as Sector 1. Different sector numbers may be specified at time of order.

EL2- ENVIRON LINKS 2 AREA WALLPLATE

EL2 Key functions: 5 crossfade Presets each addressing areas 1+2, and 1 Link on/off key, to link/unlink areas 1+2.

The Presets may be set to any address from 1 to 64, and the area address to 1 to 16. The Wallplate also has an input for an external Master take-over switch, which disables all other matching area Wallplates.

EL2 Dipswitch settings

4 Way Dipswitch

Dip4/1	Area offset 8
Dip4/2	Area offset 4
Dip4/3	Area offset 2
Dip4/4	Area offset 1

8 Way Dipswitch

Dip8/1	x
Dip8/2	x
Dip8/3	Preset offset 32
Dip8/4	Preset offset 16
Dip8/5	Preset offset 8
Dip8/6	Preset offset 4
Dip8/7	Preset offset 2
Dip8/8	Preset offset 1

EL2 Key Actions

Key 1	Preset 1+ offset, Areas 1, 2+ offset
Key 2	Preset 2+ offset, Areas 1, 2+ offset
Key 3	Preset 3+ offset, Areas 1, 2+ offset
Key 4	Preset 4+ offset, Areas 1, 2+ offset
Key 5	Preset 5+ offset, Areas 1, 2+ offset
Key 6	Link/Unlink Areas 1, 2+ offset

EL2 Other Key actions

Master On/Off (via external key-switch) 0>1 = Master On, 1>0 = Master Off

EL2 Action Of Link Keys

Pressing “Off” link keys links areas additively

Pressing any “On” link key unlinks all areas

EL2 LED Behaviour

Preset LED on	Current Preset matches this wallplate preset address
Preset LED blink	Current Preset does not match this wallplate preset address
Link LED on/off	Area Link on/off
All LEDs blink once every 2 secs	Keys disabled (another matching area wallplate is Master)

EL3- ENVIRON LINKS 3 AREA WALLPLATE**EL3 Key functions: 4 crossfade Presets each addressing areas 1+2+3, and 2 Link on/off key, to link/unlink areas 1+2, and 2+3.**

The Presets may be set to any address from 1 to 64, and the area address from to 1 to 16. The Wallplate also has an input for an external Master take-over switch, which disables all other matching area Wallplates.

EL3 Dipswitch settings**4 Way Dipswitch**

Dip4/1	Area offset 8
--------	---------------

40 THEATRELIGHT WALLPLATES MANUAL

Dip4/2 Area offset 4

Dip4/3 Area offset 2

Dip4/4 Area offset 1

8 Way Dipswitch

Dip8/1 x

Dip8/2 x

Dip8/3 Preset offset 32

Dip8/4 Preset offset 16

Dip8/5 Preset offset 8

Dip8/6 Preset offset 4

Dip8/7 Preset offset 2

Dip8/8 Preset offset 1

EL3 Key Actions

Key 1 Preset 1+ offset, Areas 1, 2, 3 + offset

Key 2 Preset 2+ offset, Areas 1, 2, 3 + offset

Key 3 Preset 3+ offset, Areas 1, 2, 3 + offset

Key 4 Preset 4+ offset, Areas 1, 2, 3 + offset

Key 5 Link Areas 1, 2 + offset

Key 6 Link Areas 2, 3 + offset

EL3 Other Key actions

Master On/Off (via external key-switch) 0>1 = Master On, 1>0 = Master Off

EL3 Action Of Link Keys

Pressing "Off" link keys links areas additively

Pressing any "On" link key unlinks all areas

EL3 LED Behaviour

Preset LED on	Current Preset matches this wallplate preset address
Preset LED blink	Current Preset does not match this wallplate preset address
Link LED on/off	Area Link on/off
All LEDs blink once every 2 secs	Keys disabled (another matching area wallplate is Master)

EL4- ENVIRON LINKS 4 AREA WALLPLATE

EL4 Key functions: 4 fixed area Link on/off keys, to link/unlink areas 1+2, areas 2+3, areas 3+4, and areas 4+1.

In addition 2 user definable Link keys link areas pre-set on the 8 way dipswitch.

The area address may be set from to 1 to 16. The Wallplate also has an input for an external Master take-over switch, which disables all other matching area Wallplates.

EL4 Dipswitch settings**4 Way Dipswitch**

Dip4/1	Area offset 8
Dip4/2	Area offset 4
Dip4/3	Area offset 2
Dip4/4	Area offset 1

8 Way Dipswitch

Dip8/1	Area 4+ offset
Dip8/2	Area 3+ offset
Dip8/3	Area 2+ offset
Dip8/4	Area 1+ offset
Dip8/5	Area 4+ offset
Dip8/6	Area 3+ offset
Dip8/7	Area 2+ offset

42 THEATRELIGHT WALLPLATES MANUAL

Dip8/8 Area 1+ offset

EL4 Key Actions

Key 1	Link Areas 1, 2 + offset
Key 2	Link Areas 2, 3 + offset
Key 3	Link Areas 3, 4 + offset
Key 4	Link Areas 4, 1 + offset
Key 5	Link Areas set on dipswitch 8, switches 1-4
Key 6	Link Areas set on dipswitch 8, switches 5-8

EL4 Other Key actions

Master On/Off (via external key-switch) 0>1 = Master On, 1>0 = Master Off

EL4 Action Of Link Keys

Pressing “Off” link keys links areas additively

Pressing any “On” link key unlinks all areas

EL4 LED Behaviour

Link LED on/off Area Link on/off

All LEDs blink once every 2 secs Keys disabled (another matching area wallplate is Master)

EL6- ENVIRON LINKS 6 AREA WALLPLATE

EL6 Key functions: 5 fixed area Link on/off keys, to link/unlink areas 1+2, areas 2+3, areas 3+4, areas 4+5, and areas 5+6. In addition another user definable Link key links areas pre-set on the 8 way dipswitch.

The area address may be set from to 1 to 8. The Wallplate also has an input for an external Master take-over switch, which disables all other matching area Wallplates.

EL6 Dipswitch settings

4 Way Dipswitch

Dip4/1 Area offset 8

Dip4/2 Area offset 4

Dip4/3 Area offset 2

Dip4/4 Area offset 1

8 Way Dipswitch

Dip8/1 x

Dip8/2 x

Dip8/3 Area 6+ offset

Dip8/4 Area 5+ offset

Dip8/5 Area 4+ offset

Dip8/6 Area 3+ offset

Dip8/7 Area 2+ offset

Dip8/8 Area 1+ offset

EL6 Key Actions

Key 1 Link Areas 1, 2 + offset

Key 2 Link Areas 2, 3 + offset

Key 3 Link Areas 3, 4 + offset

Key 4 Link Areas 4, 5 + offset

Key 5 Link Areas 5, 6 + offset

Key 6 Link Areas set on dipswitch 8, switches 1-6

EL6 Other Key actions

Master On/Off (via external key-switch) 0>1 = Master On, 1>0 = Master Off

EL6 Action Of Link Keys

Pressing "Off" link keys links areas additively

Pressing any "On" link key unlinks all areas

EL6 LED Behaviour

Link LED on/off Area Link on/off

44 THEATRELIGHT WALLPLATES MANUAL

All LEDs blink once every 2 secs

Keys disabled (another matching area wallplate is Master)

EL8- ENVIRON LINKS 8 AREA WALLPLATE

EL8 Key functions: 5 fixed area Link on/off keys, to link/unlink areas 1+2, areas 3+4, areas 5+6, areas 7+8, and all areas 1 through 8. In addition another user definable Link key links areas pre-set on the 8 way dipswitch.

The area address may be set from to 1 to 8. The Wallplate also has an input for an external Master take-over switch, which disables all other matching area Wallplates.

EL8 Dipswitch settings

4 Way Dipswitch

Dip4/1	Area offset 8
Dip4/2	Area offset 4
Dip4/3	Area offset 2
Dip4/4	Area offset 1

8 Way Dipswitch

Dip8/1	Area 8
Dip8/2	Area 7
Dip8/3	Area 6
Dip8/4	Area 5
Dip8/5	Area 4
Dip8/6	Area 3
Dip8/7	Area 2
Dip8/8	Area 1

EL8 Key Actions

Key 1	Link Areas 1, 2
Key 2	Link Areas 3, 4

Key 3	Link Areas 5, 6
Key 4	Link Areas 7, 8
Key 5	Link All Areas 1 through 8
Key 6	Link Areas set on dipswitch 8, switches 1-8

EL8 Other Key actions

Master On/Off (via external key-switch) 0>1 = Master On, 1>0 = Master Off

EL8 Action Of Link Keys

Pressing "Off" link keys links areas additively

Pressing any "On" link key unlinks all areas link bits to native

EL8 LED Behaviour

Link LED on/off	Area Link on/off
All LEDs blink once every 2 secs	Keys disabled (another matching area wallplate is Master)

TECHNICAL MANUAL

COMMAND STRUCTURE

A detailed knowledge of the Theatrelight TLNet command standard is necessary for those who want to control Nebulas directly from building management computer, or who want to add additional functionality to a Nebula system.

The structure is based on a minimum 3 byte packet consisting of a checksum, a message length byte, and a command byte. Including a message length descriptor at the head of the packet has the advantage of great flexibility in message length to allow for various data types to be transmitted, while at the same time adding to the security of the transmitted data.

Both the Stage mode and Environ mode software use a similar structure, but each mode is restricted to its own set of 128 non-interfering commands, and to a maximum packet length of 255 bytes (without using extension codes). In addition, Stage mode Scenes and Stage Show commands are non-interfering, and hence may share the same data cable.

COMMUNICATION STANDARD

The Theatrelight Stage and Environ TLNet uses the following communication standard:

Half-duplex RS485, baud rate 9600, 1 start bit, 8 data bits, 2 stop bits.

Data to be transmitted should be initiated with a high on the data line of at least 2 bit periods, and terminated with a break (low) of at least 20 bit periods before tri-stating the line.

Unlike the DMX format, TLNet has a checksum for error checking. The normal data rate of 9600 baud may easily be changed up to the DMX speed of 250 k baud if required, or to other speeds to customer request.

Most common commands vary from 3 bytes to 8 bytes. A short delay of 5 milliseconds should be inserted if transmitting multiple packets consecutively. The commands sent over the TLNet data line may be checked on any Nebula fitted with Stage or Environ software—the commands are displayed in hexadecimal format under the menus “TLNet Receive Data”, and “TLNet Transmit Data”.

The current Stage Scenes and Show commands, and Environ Presets and Links commands are described in the following pages. An updated list may be found on Theatrelight’s website: www.theatrelight.co.nz.

STAGE SCENE COMMAND CODES

The following are the currently implemented Stage mode commands:

STAGE FADE TO NEXT SCENE

Operation	Starts a crossfade to the next scene on all area matching Nebulas.
Byte 1: Checksum	= sum of [byte 2 to byte (message length)] + \$AA
Byte 2: Message length	= 4
Byte 3: Command Code	SFADNXT= \$01
Byte 4: Area Bit Code	Up to 8 bits: Bit 0 (Area 1) to Bit 7 (Area 8)

STAGE FADE TO PREVIOUS SCENE

Operation	Starts a crossfade to the previous scene on all area matching Nebulas.
Byte 1: Checksum	= sum of [byte 2 to byte (message length)] + \$AA
Byte 2: Message length	= 4
Byte 3: Command Code	SFADPRE= \$02
Byte 4: Area Bit Code	Up to 8 bits: Bit 0 (Area 1) to Bit 7 (Area 8)

STAGE FADE TO SCENE NUMBER

Operation	Starts a crossfade to the scene number on all area matching Nebulas.
Byte 1: Checksum	= sum of [byte 2 to byte (message length)] + \$AA
Byte 2: Message length	= 5
Byte 3: Command Code	SFADSCN= \$03
Byte 4: Area Bit Code	Up to 8 bits: Bit 0 (Area 1) to Bit 7 (Area 8)
Byte 5: Scene number	0 to \$3F (Scenes 1-64)

STAGE FADE CURRENT SCENE UP

Operation	Starts fading current scene levels up on all area matching Nebulas.
Byte 1: Checksum	= sum of [byte 2 to byte (message length)] + \$AA
Byte 2: Message length	= 4
Byte 3: Command Code	SFADSUP= \$04
Byte 4: Area Bit Code	Up to 8 bits: Bit 0 (Area 1) to Bit 7 (Area 8)

STAGE FADE CURRENT SCENE DOWN

Operation	Starts fading current scene levels down on all area matching Nebulas.
Byte 1: Checksum	= sum of [byte 2 to byte (message length)] + \$AA
Byte 2: Message length	= 4
Byte 3: Command Code	SFADSDN= \$05
Byte 4: Area Bit Code	Up to 8 bits: Bit 0 (Area 1) to Bit 7 (Area 8)

STAGE STOP FADING CURRENT SCENE

Operation	Stops fading current scene levels up or down on all area matching Nebulas.
Byte 1: Checksum	= sum of [byte 2 to byte (message length)] + \$AA
Byte 2: Message length	= 4
Byte 3: Command Code	SFADSTP= \$05
Byte 4: Area Bit Code	Up to 8 bits: Bit 0 (Area 1) to Bit 7 (Area 8)

STAGE MASTER ON COMMAND

Operation	Disables all area matching Wallplates except the one originating the command.
Byte 1: Checksum	= sum of [byte 2 to byte (message length)] + \$AA
Byte 2: Message length	= 4
Byte 3: Command Code	SMASTON= \$07
Byte 4: Area Bit Code	Up to 8 bits: Bit 0 (Area 1) to Bit 7 (Area 8)

STAGE MASTER OFF COMMAND

Operation	Enables all area matching Wallplates.
Byte 1: Checksum	= sum of [byte 2 to byte (message length)] + \$AA
Byte 2: Message length	= 4
Byte 3: Command Code	SMASTOF= \$08
Byte 4: Area Bit Code	Up to 8 bits: Bit 0 (Area 1) to Bit 7 (Area 8)

STAGE STORE BLACKOUT TO CURRENT SCENE

Operation	Stores a blackout to the current scene on all area matching Nebulas.
Byte 1: Checksum	= sum of [byte 2 to byte (message length)] + \$AA
Byte 2: Message length	= 4
Byte 3: Command Code	SSCCOFF= \$09
Byte 4: Area Bit Code	Up to 8 bits: Bit 0 (Area 1) to Bit 7 (Area 8)

STAGE STORE DMX+SCENE LEVELS TO CURRENT SCENE

Operation	Stores the HTP levels of DMX+Scene levels to the current scene on all area matching Nebulas.
Byte 1: Checksum	= sum of [byte 2 to byte (message length)] + \$AA
Byte 2: Message length	= 4
Byte 3: Command Code	SSCCMIX= \$0A
Byte 4: Area Bit Code	Up to 8 bits: Bit 0 (Area 1) to Bit 7 (Area 8)

STAGE STORE FULL LEVELS TO CURRENT SCENE

Operation	Stores Full levels to the current scene on all area matching Nebulas.
Byte 1: Checksum	= sum of [byte 2 to byte (message length)] + \$AA
Byte 2: Message length	= 4
Byte 3: Command Code	SSCCFUL= \$0B
Byte 4: Area Bit Code	Up to 8 bits: Bit 0 (Area 1) to Bit 7 (Area 8)

STAGE SET AREA LINKS

Operation	Sets Area bits on all area matching linkable Wallplates.
Byte 1: Checksum	= sum of [byte 2 to byte (message length)] + \$AA
Byte 2: Message length	= 4
Byte 3: Command Code	SLNKSET= \$0D
Byte 4: Area Link Bit Code	Up to 8 bits: Bit 0 (Area 1) to Bit 7 (Area 8)

STAGE CLEAR AREA LINKS

Operation	Clears Area bits to native on all area matching linkable Wallplates.
Byte 1: Checksum	= sum of [byte 2 to byte (message length)] + \$AA
Byte 2: Message length	= 4
Byte 3: Command Code	SLNKRES= \$0E
Byte 4: Area Link Bit Code	Up to 8 bits: Bit 0 (Area 1) to Bit 7 (Area 8)

STAGE START SHOW

Operation	Starts the show in show number on all area matching Nebulas (run/stop set to stop).
Byte 1: Checksum	= sum of [byte 2 to byte (message length)] + \$AA
Byte 2: Message length	= 4
Byte 3: Command Code	SSHOTT = \$10
Byte 4: Area Bit Code	Up to 8 bits: Bit 0 (Area 1) to Bit 7 (Area 8)
Byte 5: Show number	0 to \$13 (Shows 1-20)

STAGE END CURRENT SHOW

Operation	Ends and stops the current show on all area matching Nebulas (run/stop set to stop).
Byte 1: Checksum	= sum of [byte 2 to byte (message length)] + \$AA
Byte 2: Message length	= 4

Byte 3: Command Code SSHOEND = \$11
 Byte 4: Area Bit Code Up to 8 bits: Bit 0 (Area 1) to Bit 7 (Area 8)

STAGE CUE NEXT IN CURRENT SHOW

Operation Goes to next scene in the current show on all area matching Nebulas (run/stop not changed).

Byte 1: Checksum = sum of [byte 2 to byte (message length)] + \$AA
 Byte 2: Message length = 4
 Byte 3: Command Code SSHQNXT = \$12
 Byte 4: Area Bit Code Up to 8 bits: Bit 0 (Area 1) to Bit 7 (Area 8)

STAGE CUE BACK IN CURRENT SHOW

Operation Goes back a scene in the current show on all area matching Nebulas (run/stop not changed).

Byte 1: Checksum = sum of [byte 2 to byte (message length)] + \$AA
 Byte 2: Message length = 4
 Byte 3: Command Code SSHQBAK = \$13
 Byte 4: Area Bit Code Up to 8 bits: Bit 0 (Area 1) to Bit 7 (Area 8)

STAGE STOP (PAUSE) CURRENT SHOW

Operation Stops all scene auto-stepping of the current show on all area matching Nebulas (fades are allowed to complete).

Byte 1: Checksum = sum of [byte 2 to byte (message length)] + \$AA
 Byte 2: Message length = 4
 Byte 3: Command Code SSHOSTP = \$14
 Byte 4: Area Bit Code Up to 8 bits: Bit 0 (Area 1) to Bit 7 (Area 8)

STAGE RUN (PLAY) CURRENT SHOW

Operation	Allows scene auto-stepping and auto-fades of the current show on all area matching Nebulas.
Byte 1: Checksum	= sum of [byte 2 to byte (message length)] + \$AA
Byte 2: Message length	= 4
Byte 3: Command Code	SSHORUN = \$15
Byte 4: Area Bit Code	Up to 8 bits: Bit 0 (Area 1) to Bit 7 (Area 8)

STAGE GO TO SHOW SCENE NUMBER

Operation	Goes to scene number (not cue number) in current show on all area matching Nebulas (run/stop set to run).
Byte 1: Checksum	= sum of [byte 2 to byte (message length)] + \$AA
Byte 2: Message length	= 5
Byte 3: Command Code	SSHOSCN = \$16
Byte 4: Area Bit Code	Up to 8 bits: Bit 0 (Area 1) to Bit 7 (Area 8)
Byte 5: Scene number	0 to \$3F (Scenes 1-64)

STAGE FADE CURRENT SHOW DOWN

Operation	Starts fading current scene levels down of the current show on all area matching Nebulas (run/stop not changed).
Byte 1: Checksum	= sum of [byte 2 to byte (message length)] + \$AA
Byte 2: Message length	= 4
Byte 3: Command Code	SHFADDN= \$17
Byte 4: Area Bit Code	Up to 8 bits: Bit 0 (Area 1) to Bit 7 (Area 8)

STAGE STOP FADING CURRENT SHOW

Operation	Stops fading current scene levels of the current show on all area matching Nebulas (run/stop not changed).
Byte 1: Checksum	= sum of [byte 2 to byte (message length)] + \$AA

Byte 2: Message length = 4
 Byte 3: Command Code SHFDSTP= \$18
 Byte 4: Area Bit Code Up to 8 bits: Bit 0 (Area 1) to Bit 7 (Area 8)

STAGE CODES SUMMARY

A list of Stage codes for inclusion in a computer program follows:

.EQU	SFADNXT	= \$01	;Fade to Next Scene
.EQU	SFADPRE	= \$02	;Fade to Previous Scene
.EQU	SFADSCN	= \$03	;Fade to Scene number
.EQU	SFADSUP	= \$04	;Start fading current scene levels Up
.EQU	SFADSDN	= \$05	;Start fading current scene levels Dn
.EQU	SFADSTP	= \$06	;Stop fading
.EQU	SMASTON	= \$07	;Master On
.EQU	SMASTOF	= \$08	;Master Off
.EQU	SSCCOFF	= \$09	;Store blackout to current scene
.EQU	SSCCMIX	= \$0A	;Store DMX + Scenes levels to current scene
.EQU	SSCCFUL	= \$0B	;Store full levels to current scene
.EQU	SLNKSET	= \$0D	;Set Area link bits
.EQU	SLNKRES	= \$0E	;Reset Area link bits to native
.EQU	SSHOTT	= \$10	;Show start (at pause)
.EQU	SSHOEND	= \$11	;Current Show end (at pause)
.EQU	SSHQNXT	= \$12	;Cue forward in current show
.EQU	SSHQBAK	= \$13	;Cue back in current show
.EQU	SSHSTP	= \$14	;Current Show stop (pause)
.EQU	SSHORUN	= \$15	;Current Show run (play)

54 THEATRELIGHT WALLPLATES MANUAL

.EQU	SSHOSCN	= \$16	;Fade to Scene number in current Show (at play)
.EQU	SHFADDN	= \$17	;Start fading current scene levels of current show Dn
.EQU	SHFDSTP	= \$18	;Stop fading current scene levels of current show

ENVIRON PRESET COMMAND CODES

The currently implemented Environ mode commands are described below. An up to date list can be found on Theatrelight web site www.theatrelight.co.nz

ENVIRON FADE TO BLACK

Operation	Starts a fade to blackout of all area matching dimmers in all sector matching Nebulas.
Byte 1: Checksum	= sum of [byte 2 to byte (message length)] + \$AA
Byte 2: Message length	= 7
Byte 3: Command Code	EFADBLK= \$82
Byte 4: Area Bit Code lo	Up to 8 bits: Bit 0 (Area 1) to Bit 7 (Area 8)
Byte 5: Area Bit Code hi	Up to 8 bits: Bit 0 (Area 9) to Bit 7 (Area 16)
Byte 6: Sector Bit Code lo	Up to 8 bits: Bit 0 (Sector 1) to Bit 7 (Sector 8)
Byte 7: Sector Bit Code hi	Up to 8 bits: Bit 0 (Sector 9) to Bit 7 (Sector 16)

ENVIRON FADE TO PRESET NUMBER

Operation	Starts a fade to the Preset number levels of all area matching dimmers in all sector matching Nebulas.
Byte 1: Checksum	= sum of [byte 2 to byte (message length)] + \$AA
Byte 2: Message length	= 8
Byte 3: Command Code	EFADSCN= \$83
Byte 4: Area Bit Code lo	Up to 8 bits: Bit 0 (Area 1) to Bit 7 (Area 8)
Byte 5: Area Bit Code hi	Up to 8 bits: Bit 0 (Area 9) to Bit 7 (Area 16)
Byte 6: Sector Bit Code lo	Up to 8 bits: Bit 0 (Sector 1) to Bit 7 (Sector 8)
Byte 7: Sector Bit Code hi	Up to 8 bits: Bit 0 (Sector 9) to Bit 7 (Sector 16)
Byte 8: Preset number	0 to \$3F (Presets 1-64)

ENVIRON FADE CURRENT PRESET UP

Operation	Starts fading current Preset levels up of all area matching dimmers in all sector matching Nebulas
Byte 1: Checksum	= sum of [byte 2 to byte (message length)] + \$AA
Byte 2: Message length	= 7
Byte 3: Command Code	EFADSUP= \$84
Byte 4: Area Bit Code lo	Up to 8 bits: Bit 0 (Area 1) to Bit 7 (Area 8)
Byte 5: Area Bit Code hi	Up to 8 bits: Bit 0 (Area 9) to Bit 7 (Area 16)
Byte 6: Sector Bit Code lo	Up to 8 bits: Bit 0 (Sector 1) to Bit 7 (Sector 8)
Byte 7: Sector Bit Code hi	Up to 8 bits: Bit 0 (Sector 9) to Bit 7 (Sector 16)

ENVIRON FADE CURRENT PRESET DOWN

Operation	Starts fading current Preset levels down of all area matching dimmers in all sector matching Nebulas
Byte 1: Checksum	= sum of [byte 2 to byte (message length)] + \$AA
Byte 2: Message length	= 7
Byte 3: Command Code	EFADSDN= \$85
Byte 4: Area Bit Code lo	Up to 8 bits: Bit 0 (Area 1) to Bit 7 (Area 8)
Byte 5: Area Bit Code hi	Up to 8 bits: Bit 0 (Area 9) to Bit 7 (Area 16)
Byte 6: Sector Bit Code lo	Up to 8 bits: Bit 0 (Sector 1) to Bit 7 (Sector 8)
Byte 7: Sector Bit Code hi	Up to 8 bits: Bit 0 (Sector 9) to Bit 7 (Sector 16)

ENVIRON STOP FADING CURRENT PRESET

Operation	Stops fading current Preset levels up or down of all area matching dimmers in all sector matching Nebulas
Byte 1: Checksum	= sum of [byte 2 to byte (message length)] + \$AA
Byte 2: Message length	= 7
Byte 3: Command Code	EFADSTP= \$85

Byte 4: Area Bit Code lo	Up to 8 bits: Bit 0 (Area 1) to Bit 7 (Area 8)
Byte 5: Area Bit Code hi	Up to 8 bits: Bit 0 (Area 9) to Bit 7 (Area 16)
Byte 6: Sector Bit Code lo	Up to 8 bits: Bit 0 (Sector 1) to Bit 7 (Sector 8)
Byte 7: Sector Bit Code hi	Up to 8 bits: Bit 0 (Sector 9) to Bit 7 (Sector 16)

ENVIRON MASTER ON COMMAND

Operation	Disables all sector/area matching Wallplates except the one originating the command.
Byte 1: Checksum	= sum of [byte 2 to byte (message length)] + \$AA
Byte 2: Message length	= 7
Byte 3: Command Code	EMASTON= \$87
Byte 4: Area Bit Code lo	Up to 8 bits: Bit 0 (Area 1) to Bit 7 (Area 8)
Byte 5: Area Bit Code hi	Up to 8 bits: Bit 0 (Area 9) to Bit 7 (Area 16)
Byte 6: Sector Bit Code lo	Up to 8 bits: Bit 0 (Sector 1) to Bit 7 (Sector 8)
Byte 7: Sector Bit Code hi	Up to 8 bits: Bit 0 (Sector 9) to Bit 7 (Sector 16)

ENVIRON MASTER OFF COMMAND

Operation	Enables all sector/area matching Wallplates.
Byte 1: Checksum	= sum of [byte 2 to byte (message length)] + \$AA
Byte 2: Message length	= 7
Byte 3: Command Code	EMASTOF= \$88
Byte 4: Area Bit Code lo	Up to 8 bits: Bit 0 (Area 1) to Bit 7 (Area 8)
Byte 5: Area Bit Code hi	Up to 8 bits: Bit 0 (Area 9) to Bit 7 (Area 16)
Byte 6: Sector Bit Code lo	Up to 8 bits: Bit 0 (Sector 1) to Bit 7 (Sector 8)
Byte 7: Sector Bit Code hi	Up to 8 bits: Bit 0 (Sector 9) to Bit 7 (Sector 16)

ENVIRON STORE BLACKOUT TO CURRENT PRESET

Operation	Stores a blackout to the current Preset on of all area matching dimmers in all sector matching Nebulas.
-----------	---

58 THEATRELIGHT WALLPLATES MANUAL

Byte 1: Checksum	= sum of [byte 2 to byte (message length)] + \$AA
Byte 2: Message length	= 7
Byte 3: Command Code	ESCCOFF= \$89
Byte 4: Area Bit Code	Up to 8 bits: Bit 0 (Area 1) to Bit 7 (Area 8)

ENVIRON STORE DMX+PRESET LEVELS TO CURRENT PRESET

Operation	Stores the HTP levels of DMX and current Preset levels to all area matching dimmers preset levels in all sector matching Nebulas.
Byte 1: Checksum	= sum of [byte 2 to byte (message length)] + \$AA
Byte 2: Message length	= 7
Byte 3: Command Code	ESCCMIX= \$8A
Byte 4: Area Bit Code lo	Up to 8 bits: Bit 0 (Area 1) to Bit 7 (Area 8)
Byte 5: Area Bit Code hi	Up to 8 bits: Bit 0 (Area 9) to Bit 7 (Area 16)
Byte 6: Sector Bit Code lo	Up to 8 bits: Bit 0 (Sector 1) to Bit 7 (Sector 8)
Byte 7: Sector Bit Code hi	Up to 8 bits: Bit 0 (Sector 9) to Bit 7 (Sector 16)

ENVIRON STORE FULL LEVELS TO CURRENT PRESET

Operation	Stores Full levels to all area matching dimmers preset levels in all sector matching Nebulas.
Byte 1: Checksum	= sum of [byte 2 to byte (message length)] + \$AA
Byte 2: Message length	= 7
Byte 3: Command Code	ESCCFUL= \$8B
Byte 4: Area Bit Code lo	Up to 8 bits: Bit 0 (Area 1) to Bit 7 (Area 8)
Byte 5: Area Bit Code hi	Up to 8 bits: Bit 0 (Area 9) to Bit 7 (Area 16)
Byte 6: Sector Bit Code lo	Up to 8 bits: Bit 0 (Sector 1) to Bit 7 (Sector 8)
Byte 7: Sector Bit Code hi	Up to 8 bits: Bit 0 (Sector 9) to Bit 7 (Sector 16)

ENVIRON SET AREA LINKS

Operation	Sets Area links on all sector/area matching linkable Wallplates.
Byte 1: Checksum	= sum of [byte 2 to byte (message length)] + \$AA
Byte 2: Message length	= 7
Byte 3: Command Code	ELNKSET= \$8D
Byte 4: Area Bit Code lo	Up to 8 bits: Bit 0 (Area 1) to Bit 7 (Area 8)
Byte 5: Area Bit Code hi	Up to 8 bits: Bit 0 (Area 9) to Bit 7 (Area 16)
Byte 6: Sector Bit Code lo	Up to 8 bits: Bit 0 (Sector 1) to Bit 7 (Sector 8)
Byte 7: Sector Bit Code hi	Up to 8 bits: Bit 0 (Sector 9) to Bit 7 (Sector 16)

ENVIRON CLEAR AREA LINKS

Operation	Clears Area bits to native on all sector/area matching linkable Wallplates.
Byte 1: Checksum	= sum of [byte 2 to byte (message length)] + \$AA
Byte 2: Message length	= 7
Byte 3: Command Code	ELNKRES= \$8E
Byte 4: Area Bit Code lo	Up to 8 bits: Bit 0 (Area 1) to Bit 7 (Area 8)
Byte 5: Area Bit Code hi	Up to 8 bits: Bit 0 (Area 9) to Bit 7 (Area 16)
Byte 6: Sector Bit Code lo	Up to 8 bits: Bit 0 (Sector 1) to Bit 7 (Sector 8)
Byte 7: Sector Bit Code hi	Up to 8 bits: Bit 0 (Sector 9) to Bit 7 (Sector 16)

ENVIRON CODES SUMMARY

A list of the Environ codes for inclusion in a computer program follows:

.EQU EFADSCN = \$83	;Fade area match dimmers to Preset
.EQU EFADBLK = \$82	;Fade area match dimmers to Black
.EQU EFADSUP = \$84	;Start fading area match dimmers Up
.EQU EFADSDN = \$85	;Start fading area match dimmers Dn

60 THEATRELIGHT WALLPLATES MANUAL

.EQU EFADSTP = \$86 ;Stop fading area match dimmers
.EQU EMASTON = \$87 ;Master On
.EQU EMASTOF = \$88 ;Master Off
.EQU ESCCOFF = \$89 ;Store area match blackout to current preset
.EQU ESCCMIX = \$8A ;Store area match DMX+Presets to current preset
.EQU ESCCFUL = \$8B ;Store area match full to current preset
.EQU ELNKSET = \$8D ;Set Area link bits
.EQU ELNKRES = \$8E ;Reset Area link bits to native

SPECIFICATIONS

CONSTRUCTION

Injection moulded plastic panel. Legend can be laser engraved or silk-screened in solvent and abrasion resistant two pot epoxy ink to customer's order.

ELECTRONICS

Low power flash microprocessor with internal EEPROM for long life storage of all parameters.

PUSH BUTTONS

"Alps" brand computer keys with custom moulded keycaps, and blue LEDs.

POWER REQUIREMENTS

Power requirement per wallplate is 1.5 milli-amps with one LED on. Power is sourced from the data line. Each Nebula on the data line can provide a 12 volt 200ma constant current supply.

DATA CONNECTION

RS-485 Control Input: via RJ 45 connectors mounted on the rear PCB. Each Wallplate presents 1/10th normal RS-485 unit load.

OTHER CONNECTIONS

Master Switch: PCB pins for Master Switch connection (open = Master Off, shorted = Master On)

Line termination: PCB link pins for 120 ohm terminating resistor (open = resistor not in circuit, shorted = resistor in circuit)

Diagnostic socket: PCB socket for programming and diagnostic purposes (Theatreight technicians use only).

Theatreight contact address:

THEATRELIGHT LTD

PO BOX 13159

AUCKLAND, NEW ZEALAND

Phone 64-9-622-1187, 636-5805

Fax 64-9-636-5803

Web site: www.theatreight.co.nz

E-mail: sales@theatreight.co.nz

DIMENSIONS

WALLPLATE DIMENSIONS

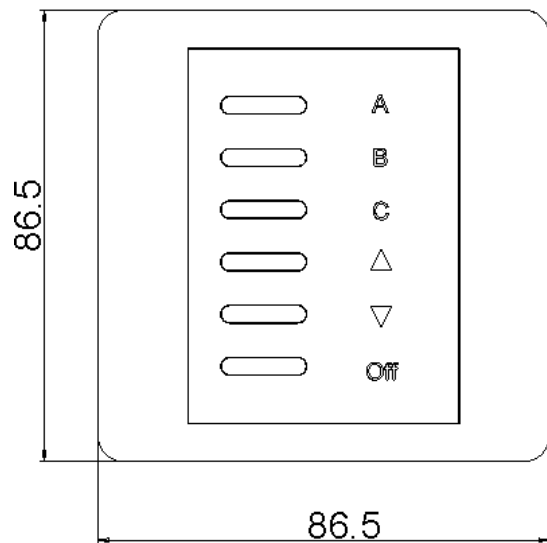

FLUSHBOX DIMENSIONS

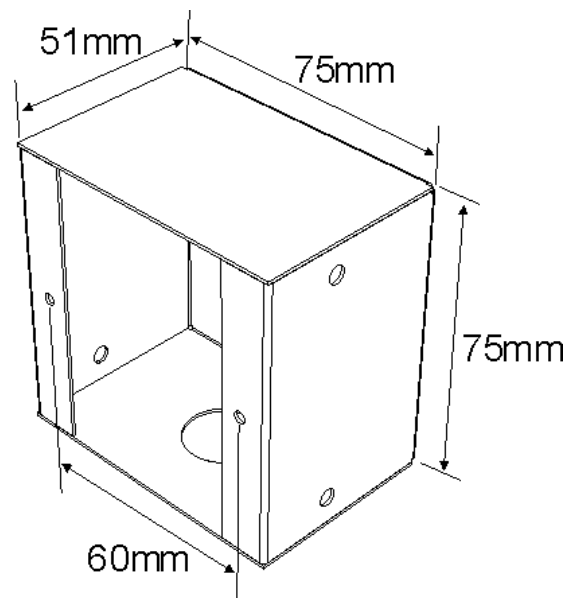

GLOSSARY

AREA	An area lit by one or more dimmers.
AREA CODE	An address code which controls dimmers set to the same area number.
BLACKOUT	All lights out.
CHANNEL	One of the controlled output lines from a lighting desk; or a dimmer channel.
CHASE	A repetitive pattern of lighting changes.
CROSS-FADE	A smooth change from one lighting state to another.
CUE	An action or time event which results in a lighting change; also the lighting state following the cue
DBO	Dead Black-out: no light on stage.
DIMMER	A power controller which changes the brightness of lights connected to it.
DIPLESS	Applied to a cross-fade where a dimmer set at the same level on both the incoming and outgoing lighting states does not change level during the cross-fade.
DMX-512	A method of transmitting dimmer levels digitally over a two wire cable. (Digital MultipleX, 512 dimmers)
EEPROM	Electrically Erasable Programmable Read Only Memory: Flash Memory.
EMI	Electro-Magnetic Interference. Electrical noise.
ERASE	To clear and reset the memory.
FADER	A slider control.
FADE TIME	The time taken to complete a fade from full off to full on.
HTP	Highest Takes Precedence: the highest command level is used as the controlling level
LCD	Liquid Crystal Display
LED	Light Emitting Diode.
LEVEL	The brightness of a dimmer as a number from 0 (off), to 10 (full on), or from 0% to 100%.
LTP	Latest Takes Precedence: the latest command level is used as the controlling level
MASTER	Overall control of a number of levels or other major function.

64 THEATRELIGHT WALLPLATES MANUAL

MCB	Miniature Circuit Breaker- a re-settable current protection device.
MIMIC DISPLAY	A display often using Light Emitting Diodes (LEDs).
NON-DIM	A dimmer set to Non-dim acts like a switch: on or off
PRESET	A set of dimmer levels; on a control panel, a row of faders representing the channels in a scene.
PREVIEW	To view a set of recorded levels without showing on stage.
SCENE	A set of dimmer levels.
SCENEMASTER	A master fader which controls the playback of a scene of recorded levels.
SCR	Silicon Controlled Rectifier. A unidirectional power switch used in dimmers
SECTOR	A set of areas (qv).
SECTOR CODE	An address code which controls dimmer packs set to the same sector number.
SEQUENCE	A repetitive pattern of lighting changes.
SHOW	A sequence of cues.
SOFTSTART	A minimum fade up time programmed into a dimmer to enhance lamp life.
SNAP FADE	An instant change from one lighting state to another.
STEP	To change from one scene or cue to another. Also, one scene of a Show or Chase.
TRIAC	A bi-directional power switch. Triac dimmers should be used with care on inductive and capacitive loads.
USITT	United States Institute of Theatre Technicians. Arbiters of the DMX-512 standard.