



# INTERCOM SYSTEMS

AUDIO / BROADCAST / COMMUNICATION PRODUCTS



# Index

## WIRELESS INTERCOM

<b>WBS-200HD:</b> Single channel wireless base station .....	<b>4</b>
<b>WBS-202HD:</b> Dual channel wireless base station .....	<b>5</b>
<b>WBP-200HD:</b> <i>Compact Series</i> single channel wireless beltack .....	<b>6</b>
<b>WBP-202HD:</b> <i>Compact Series</i> dual channel "Manager" wireless beltack .....	<b>6</b>
<b>WBPC-200:</b> <i>Compact Series</i> beltack charger .....	<b>6</b>
<b>WBP-210HD:</b> <i>EXTREME Series</i> single channel wireless beltack .....	<b>7</b>
<b>WBP-212HD:</b> <i>EXTREME Series</i> dual channel "Manager" wireless beltack.....	<b>7</b>
<b>WBPC-210:</b> <i>EXTREME Series</i> beltack charger .....	<b>8</b>
<b>WBP-210HD FL:</b> <i>EXTREME Series</i> single channel wireless beltack with beacon light.....	<b>8</b>
<b>WBP-212HD FL:</b> <i>EXTREME Series</i> dual channel wireless beltack with beacon light .....	<b>8</b>
<b>WAM-100, WAM-100/2, WAM-100S, WAM-100/2S:</b> Intercom headsets .....	<b>9</b>
<b>WAM-100/2L, WAM-100/2SEC:</b> Special intercom headsets .....	<b>9</b>
<b>WBFC-200, 202, 210 &amp; 212:</b> Briefcases for beltacks and chargers .....	<b>10</b>
<b>WBFC-200F, 202F, 210F y 212F</b> Flight-cases for full intercom systems .....	<b>10</b>
<b>R-54135, R-54136, DA-P6060, BC-0822:</b> Antennas for wireless intercom systems .....	<b>11</b>
<b>AS-MB200, AS-MB200-2:</b> Standard antenna supports .....	<b>11</b>
<b>AS-2W:</b> Antenna cable splitter.....	<b>11</b>
<b>SY-200:</b> Synchronism cable for wireless base stations .....	<b>11</b>
<b>ECXX-MM:</b> Antenna extension cables .....	<b>11</b>

## WIRED INTERCOM

<b>EF-200:</b> Dual channel intercom base station .....	<b>12</b>
<b>EF-204:</b> 4 channels intercom base station .....	<b>13</b>
<b>EM-201:</b> Single channel beltack .....	<b>14</b>
<b>EM-201FL:</b> Single channel beltack with beacon light .....	<b>14</b>
<b>EM-203 "TUBECOM":</b> Compact size single channel unit .....	<b>14</b>
<b>EM-202:</b> Dual channel intercom beltack .....	<b>15</b>
<b>5P3-202:</b> 5/3 pin wiring splitter-combiner .....	<b>15</b>
<b>ES-200:</b> Remote dual channel desktop station .....	<b>16</b>
<b>ES-201:</b> Single channel remote station .....	<b>16</b>
<b>4W2-200:</b> 4/2 wires universal interface .....	<b>17</b>
<b>EB-200:</b> <i>Bluetooth™</i> extension .....	<b>17</b>
<b>AM-100/2BT:</b> Recommended headset for EB-200 .....	<b>17</b>
<b>FL-200:</b> Accessory beacon light .....	<b>18</b>
<b>PS-200:</b> Power supply for basic intercom systems .....	<b>18</b>
<b>OR-1-200:</b> Rack mounting accessory for <i>PS-200</i> .....	<b>18</b>
<b>PC-4-200:</b> Mounting accessory for beltacks & interfaces .....	<b>19</b>
<b>MF-200:</b> <i>Gooseneck</i> microphone for base stations .....	<b>19</b>
<b>AM-100, AM-100/2, AM-100S, AM-100/2S:</b> Intercom headsets .....	<b>20</b>
<b>AM-100/2L, AM-100/2SEC:</b> Special intercom headsets .....	<b>20</b>
<b>MTX-416:</b> Intercom/audio programmable switching matrix .....	<b>21</b>
<b>EC-200, ER-200 &amp; ES-203CL:</b> <i>Cue Light Series</i> .....	<b>22-23</b>



# ALTAIR

## Intercom Systems

ALTAIR intercom systems have helped professionals face their challenges for over three decades. The simplicity and reliability of their design, their great compatibility and a fast learning curve have gradually led our communication products to a leading position in the communications field.

To this day, ALTAIR intercom systems have moved into new areas, gradually implementing new models and solution and adapting them to new applications.

The intercom system concept introduced by ALTAIR is modular and scalable: from a small two-point wired Intercom system to a mixed wired & wireless multi-channel network.

ALTAIR catalogue includes a varied list of products, offering communication solutions for a wide range of professional applications and environments: Live music, theatre, corporate events, TV studios, broadcast, ENG, camera CCU's, cinema, sports, industrial communication, education/ simulation systems, etc.

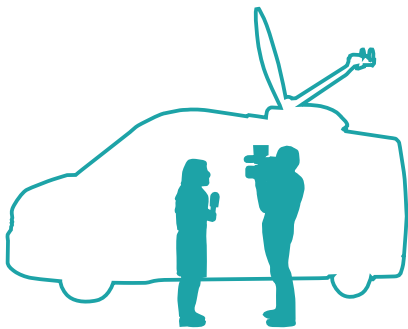

**Compatibility:** ALTAIR Intercom systems are designed in compliance with the industry standards, offering basic compatibility with major intercom manufacturers.

**Reliability:** Our production and quality control system and our extensive experience in the manufacture of ProAudio devices guarantee the highest reliability of our products.

**Innovation:** The continuous development and implementation of new technologies in our devices are daily challenges that motivate and maintain our brand's original purpose.

### WB-200

#### Wireless Intercom Series

Updated with a higher audio quality, the series consists of two different base station models, with capacity for up to 4 and 8 wireless belt packs respectively, and two alternative series of belt packs ("Compact" or "EXTREME") to fit different needs and budgets.

Base station compatibility makes it possible to create mixed wired and wireless intercom solutions. The system operates in *full duplex* mode and allows hands-free operation. Several stations can be linked in order to achieve the required number of wireless belt packs.

The audio band used by ALTAIR intercom systems maximizes human voice intelligibility, ensuring clear communication. Furthermore, thanks to the radio frequency used by our systems, professionals will benefit from interference-free communication (no interferences from other wireless systems such as *in-ear* monitoring, IEMs, wireless mics, etc.).

### Serie E-200

#### Wired Intercom

E-200 series offers a wide variety of products, including single and dual channel belt packs, single channel belt pack with built-in beacon light, hands-free stations, cue-light transmitters and receivers, *Bluetooth™* interfaces/extensions and so on.

ALTAIR's wired intercom is based on communication via standard microphone cable (2 wires + shield), or multi-pair cables when the design of the intercom network requires it.



The power supply included in the master station can power all the devices connected to the intercom network (belt packs, remote stations, cue-light devices, etc.), making the installation fast and easy.



# Wireless intercom systems

WB-200 Series

## WBS-200HD

Single channel base station

### Specifications

**Power requirements:** 90-264 VAC/ 50-60Hz/ 50 VA.

**RF:** 1900 MHz frequency band, depending on the country.

**Number of beltacks per base station:** 1 to 4 wireless beltacks + up to 20 cable units.

**Connections:** 2 x wired intercom line (XLR-3F & XLR-3M) PRG in, PA out, headset connector.

**Remote functions:** "MIC KILL", "BUZZ KILL".

**Dimensions/weight:** 1 x 19" RU x 150 mm/ 3 kg Net.

WBS-200HD wireless intercom base station has been designed to operate in standalone mode, enabling secure *full duplex* communication between the base station operator and a maximum of **4 single channel wireless beltacks** sharing a single partyline.

On top of this, the station is equipped with connectors to create two independent wired intercom lines (one of them linked to the wireless beltacks) and it can communicate with **up to 20 cable beltacks** and/or stations (*E-200 Series*).

Wired/wireless compatibility of our stations is a key to ALTAIR's success, as it allows the user to set up mixed communication solutions to fit the particular requirements of different installations. Furthermore, this station is compatible with all major 2 and 4 wire intercom systems designed by different manufacturers.

The system can be expanded by linking several stations, all of them connected wirelessly or via cable to their respective beltacks.

Depending on the situation and in order to simplify the installation and maintenance procedures, the power for the wireless base station can be remotely supplied from a wired intercom station (*EF-200* or *EF-204*).

### Application example:

Basic setup. The system can be easily expanded with a wired intercom system, i.e. *EM-201*, *EM-202* beltacks.

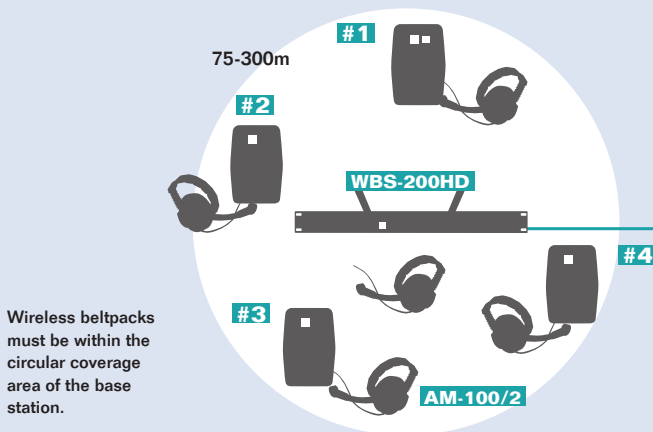

Wireless beltacks must be within the circular coverage area of the base station.

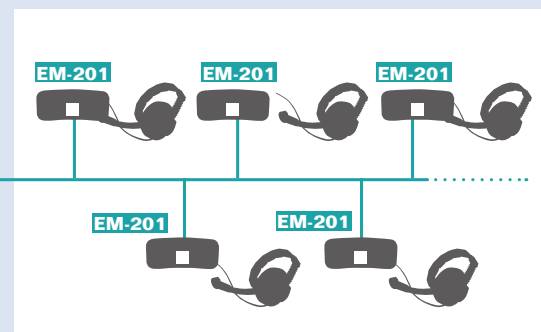

### Key features

- Digital system; digitally encrypted communication.
- License free frequency band.
- Diversity antennas system to minimize *dropouts*.
- Two detachable Omni antennas supplied with the station (optional connection of higher range directional and omnidirectional antennas)

- The system is free of interferences caused by IEMs, *Wi-Fi* or wireless mics.
- Apart from the 4 wireless beltacks, the station can power up to 20 wired beltacks.
- Compatible with both Compact and *EXTREME* series wireless beltacks.
- Clear and powerful *wideband* audio communication. DSP assisted contoured voice link with *EchoSup* feature.



WBS-202HD dual channel wireless intercom station has been designed to operate in standalone mode, enabling secure *full duplex* communication between the base station operator and a **maximum of 8 wireless beltpacks**. This station is provided with two independent radio links, allowing the user to choose between two different operation modes: "A / B" separate channels (4 beltpacks on each channel) or "A + B" (both channels are linked together to create a single partyline with up to 8 wireless beltpacks).

WBS-202HD allows the use of maximum 8 single channel beltpacks, or 6 single channel beltpacks plus 2 dual channel "manager" beltpacks.

**PLEASE NOTE THAT ONLY 1x DUAL CHANNEL BELTPACK CAN BE REGISTERED TO EACH RADIO BLOCK (R1 and R2).**

Apart from the wireless beltpacks, **the station can power up to 20 wired intercom beltpacks** and/or stations (*E-200 Series*) and it's compatible with all major 2 and 4 wires intercom systems by other manufacturers.

The system can be expanded by linking several stations, all of them connected wirelessly or via cable to their respective beltpacks.

## WBS-202HD

Dual channel base station

### Specifications

**Power requirements:** 90-250 VAC/ 50-60Hz/ 50 VA.

**RF:** 1900 MHz frequency band, depending on the country.

**Number of beltpacks per base station:** 1 to 8 wireless units + up to 20 cable units.

**Connections:** 2 x cable intercom line (A/B): XLR-3F & XLR-3M; PRG in; PA out; headset connector; SA Output.

**Remote functions:** "MIC KILL", "BUZZ KILL" and relay contacts.

**Dimensions/weight:** 1 x 19"RU x 210 mm/ 3.2 kg Net.

### Application example / Operating modes

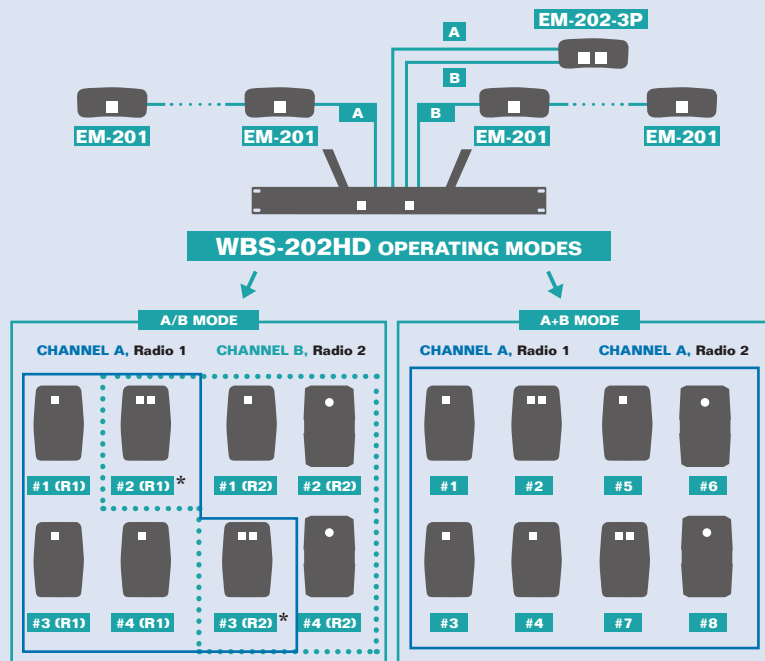

\* Dual channel beltpacks could select communicate with A or B channels individually or with both A+B at the same time.

Depending on the situation and in order to simplify the installation and maintenance procedures, the power for the wireless base station can be remotely supplied from a wired intercom station (*EF-200* or *EF-204*).

### Key features

- Digital system; digitally encrypted communication.
- License free frequency
- Diversity antennas system to minimize dropouts.
- Two detachable *Omni* antennas are supplied with the station (optional connection of higher range directional and omnidirectional antennas)
- The system is free of interferences caused by IEMs, *Wi-Fi* or wireless mics.
- All-in-one wireless and wired dual channel station (up to 8 wireless beltpacks and up to 20 wired beltpacks and/or remote stations).
- Compatible with both Compact and *EXTREME* series wireless beltpacks.
- Clear and powerful *wideband* audio communication. DSP assisted contoured voice link with *EchoSup* feature.



### WBP-200HD

Single channel Wireless beltpack



### WBP-202HD

Dual channel Manager beltpack



### WBP-200HD / WBP-202HD Specifications

**Battery:** 3.6V Ni-MH. Up to 10 hours autonomy. 4 hours full charge time.

**Range:** 50-300m around base station.

**Headset Connector:** miniature XLR-4M.

**"CALL" indicators:** Luminous, acoustic (buzzer) and vibration.

**Dimensions/weight:** 120x80x25 mm/ 175 gr Net (including batteries).

#### WBP-200HD Key features

- **Compatibility:** WBS-200HD is compatible with any ALTAIR Wireless base station.
- Ergonomic and lightweight design.
- Internal *diversity* antennas.
- Battery life: 10 hours in conversation mode (up to 50 hours in *call receive* mode).
- Battery charger: WBPC-200 (sold separately).
- New MIC key on upper panel for easier access.

Presented in a small size casing, *Compact Series* beltpacks offer unmatched price-quality ratio, impressive range and remarkable autonomy. Antennas are located inside the beltpack case, allowing a comfortable belt fitting. Audio circuits include DSP processing to improve voice intelligibility in noisy environments. Furthermore, echo suppression and related processing ensure clear and fatigue-free communication during extended periods of use.

As for the calls, both audio and vibration functions are available to ensure that users perceive incoming calls.

Thanks to its general low-power circuitry design, *Compact Series* beltpacks offer up to 10 hours autonomy in standard *full duplex* mode.

Battery status can be easily checked using the multi-purpose front panel leds. Several options can also be activated using the front panel keys (Buzzer & Vibrator ON/OFF, phantom power for headsets with electret mics, etc.).

For those professionals requiring maximum autonomy, the beltpack features a low consumption "call receive" mode. An optional converter lead "AMS-200" (sold separately) is available on demand to convert the "miniature" XLR headset connector to a standard size XLR.

"Out of range" led indicator helps the user be aware of the coverage area limits in order to prevent possible communication dropouts.

WBP-200HD beltpacks are charged using a WBPC-200 charger (up to 4 beltpacks per charger).

#### WBP-202HD Key features

- **Compatibility:** WBS-202HD & WBS-202 base stations.
- Dual channel wireless beltpack.
- Designed for management requirements.
- Separate "A/B" or combined "A+B" channel listening
- Talk button selection per channel: A, B or A+B
- Stage *Announcement* key to send messages to the P.A. system.

This model allows simultaneous or independent communication with both channels (A & B). WBP-202HD includes special functions to help manage two separate working teams. The unit allows selective listening of either one channel or a mix of both at the same time, as well as selective call reception from both channels. *Stage Announcement* feature allows the user to address direct messages to the P.A. system. Occasionally, this dual channel beltpack can be registered as a single channel beltpack (when used along with an "HD" base station and with limited compatibility).

### WBPC-200

Wireless beltpack charger



Allows simultaneous charge of up to 4 *Compact Series* wireless beltpacks. Worldwide voltage selector; "fast charge/trickle", "open" and "short-circuit" indicators for each lead.

#### Specifications

**Power requirements:** 110-120/ 220-240 VAC/ 50-60Hz/ 15 VA.

**Connectors:** Plugs for 1 to 4 beltpacks.

**Full charge time:** 4 hours.

**Indicators:** Fast Charge, Trickle, Open and Short-Circuit.

**Dimensions/weight:** 84x55x155 mm/ 650 gr Net.

# EXTREME series beltpacks

## WBP-210HD

Single channel *Wireless* beltpack



## WBP-212HD

Dual channel *Wireless* beltpack



### WBP-210HD/WBP-212HD Specifications:

- Battery:** 3,6V Li-ion battery. 14 Hours autonomy; 4 hours full charge time.
- Range:** 50-300m around base station.
- Headset connectors:** Standard size XLR-4M and "miniature" XLR-4M.
- "CALL" indicators:** Luminous, acoustic (buzzer) and vibration.
- Dimensions/weight:** 145x93x35 mm/ 350 gr Net (including battery).

### WBP-210HD Key features

- Compatibility: *WBS-200HD*, *WBS-202HD*, *WBS-200* & *WBS-202* base stations.
- Rugged case design. Rubber corners.
- Internal diversity antennas.
- *Bluetooth* connectivity.
- Battery life (main battery): up to 14 hours in conversation mode.
- Secondary battery: 1 x alkaline AA adds up to 4 hours extra operation time.
- "Mic" and "Volume" keys on upper panel.
- USB connector for charge and firmware updates.
- Battery charger: *WBPC-210* (sold separately).
- Phantom power for headsets equipped with *electret* microphone.

### WBP-212HD Special features

- Compatibility: *WBS-202HD* & *WBS-202* base stations.
- Dual channel wireless beltpack.
- Designed according to managers requirements.
- Separate "A/B" or combined "A+B" channel listening.
- "Talk" button selection per channel: A, B or A+B
- "Mic" and "Channel Selection" keys on upper panel.
- *Stage announcement* function to send messages to the P.A. system.

*WBP-210HD* and *WBP-212HD* beltpacks have been specifically designed to offer great performance in the most demanding applications, such as live music festivals, TV ENG, outdoor cinema shots and other outdoor applications requiring maximum reliability and resistance. *EXTREME Series* beltpacks feature additional functions to ease their use in stressful working conditions: Standard size 4 pin XLR headset connector for higher durability, long life Li-Ion battery, secondary battery socket, "keyboard lock" function to prevent undesired actuation of the keys, bigger illuminated keys and many more.

Presets information, remaining battery time, coverage, and other valuable information can be easily checked using a handy colour screen. *EXTREME Series* and *Compact Series* beltpacks can be registered together to the same base station.



As an exclusive function, these beltpacks can operate in "TWIN MODE", which means that two beltpacks can be wirelessly connected one to each other without the need of a base station.

On top of all this, *EXTREME Series* beltpacks are now equipped with a built-in *Bluetooth*® interface, allowing the operator to use wireless BT headsets. Other specifications are common to all *ALTAIR* wireless beltpacks: internal *diversity* antennas, high listening level, maximum number of beltpacks per base station, range, etc.

Occasionally, *WBP-212HD* beltpack can be registered as a single channel beltpack (when used along with an "HD" base station and with limited compatibility).

Finally, *EXTREME Series* beltpacks can be ordered on demand with a built-in beacon light to help users notice incoming calls even in the loudest environments (*WBP-210HD FL* and *WBP-212HD FL* models, see next page).



### WBP-210HD FL WBP-212HD FL

Single and dual channel *EXTREME* beltacks with built-in beacon light

*WBP-210HD FL* (single channel) and *WBP-212HD FL* (dual channel) are the most complete beltacks in our catalogue. These models offer all the features and functions of *EXTREME Series* beltacks, plus a built-in high luminosity beacon light to help the operator notice incoming calls when working in loud environments (live music festivals, for example).



### WBPC-210

Wireless beltack charger

Allows simultaneous charge of up to 4 *EXTREME Series* wireless beltacks. Worldwide voltage selector; "charging / trickle", "open" and "short-circuit" indicators for each lead.



### Specifications

**Specifications:** Power requirements 90-264 VAC / 50-60Hz / 20 VA.  
**Connectors:** 4 beltack plugs.  
**Full charge time:** 4 hours.  
**Indicators:** Charging, Terminating (trickle), Open and Short-Circuit.  
**Dimensions/weight:** 84x55x155 mm / 290 gr Net.





# Intercom headsets (miniature XLR-4F connector)

## WAM-100/2

Single muff headset



### Specifications

**Microphone:** dynamic, cardioid, 200 Ohm.  
**Headset:** WAM-100/2 -> 400Ω;  
 WAM-100 -> 200 Ohm (2 x 400 Ohm).  
**Weight:** WAM-100/2 -> 245 gr Net;  
 WAM-100 -> 330 gr Net.

Our most demanded headset model. Professional quality, high durability single-ear headset. High noise isolation thanks to its closed design; dynamic microphone for higher durability.

## WAM-100

Double muff headset



Professional quality, high durability dual-ear headset. High noise isolation thanks to its closed design; dynamic microphone for higher durability.

## WAM-100/2S

Single muff headset w/rotating microphone



### Specifications

**Microphone:** dynamic, cardioid, 200 Ohm.  
**Headset:** WAM-100/2S -> 400Ω;  
 WAM-100S -> 200 Ohm (2 x 400 Ohm).  
**Weight:** WAM-100/2S -> 350 gr Net;  
 WAM-100S -> 450 gr Net.

Our most complete series of headsets. Professional quality single-ear headset featuring extra noise isolation. Rotatable microphone boom acting as microphone "on/off" switch. Recommended model for loud environments.

## WAM-100S

Dual muff headset w/rotating microphone



Our most complete series of headsets. Professional quality dual-ear headset featuring extra noise isolation. Rotatable microphone boom acting as microphone "on/off" switch. Recommended model for loud environments.

## WAM-100/2SEC

Earphone



### Specifications

**Description:** in-ear lightweight headset with electret microphone.  
**Dimensions/weight:** 170x80x30 mm (packed) / 33 gr Net.

Intended for those applications requiring a discrete solution in a very small size.

This in-ear model features an *electret* microphone with two operation modes:

"PTT" (*push-to-talk*) and "VOX" (*always active*).  
*Phantom* power required (provided by the beltpack).

## WAM-100/2L

Single muff lightweight headset



### Specifications

**Description:** on-ear lightweight headset with *electret* microphone.  
**Dimensions/weight:** 165x189x55 mm (packed) / 73 gr Net.

Lightweight headset with *electret* microphone, perfect for office environments or for those situations in which the use of a standard intercom headset is not possible due to aesthetic reasons. This model is not suitable for too loud environments. *Phantom* power required (provided by the beltpack).

NOTE: All these models can be ordered on demand with 5 pin XLR connector or others.

The following storage and transport solutions are perfect add-ons for ALTAIR wireless intercom systems. All these models allow charging the belt packs while they are stored, which makes them great organizing tools to ensure that every belt pack is safely stored and connected to the charger after every working session. Full-system flight cases are a great tool for rental and touring companies, as they allow a fast set up of the system and its operation in portable applications.

Note: The images are shown for illustrative purposes only. Flight-cases & briefcases are supplied empty.

### WBFC-200

Compact Series



#### Specifications

##### Dimensions/weight:

495x390x130 mm / 4 kg Net  
(5,65 Kg full).

**Capacity:** 1 charger (WBPC-200) and 4 belt packs (Compact Series).

### WBFC-202

Compact Series



#### Specifications

##### Dimensions/weight:

670x420x130 mm / 5,8 kg Net  
(8,95 kg full).

**Capacity:** 2 chargers (WBPC-200) and 8 belt packs (Compact Series).

### WBFC-200F

Compact Series

#### Specifications

##### Dimensions/weight:

530x560x205 mm / 11.1 kg Net  
(16.7 Kg full).



**Capacity:** 1 base station, 1 charger (WBPC-200), 4 belt packs (Compact Series) & 5 headsets\*.

### WBFC-202F

Compact Series



#### Specifications

##### Dimensions/weight:

530x560x295 mm / 14.5 kg Net  
(21 Kg full).

**Capacity:** 1 base station, 2 chargers (WBPC-200), 8 belt packs (Compact Series) & 9 headsets\*.

### WBFC-210

Extreme Series



#### Specifications

##### Dimensions/weight:

495x390x130 mm / 4.2 kg Net  
(6 Kg full).

**Capacity:** 1 charger (WBPC-210) and 4 belt packs (EXTREME Series).

### WBFC-212

Extreme Series



#### Specifications

##### Dimensions/weight:

670x420x130 mm / 6.2 kg Net  
(9.8 Kg full).

**Capacity:** 2 chargers (WBPC-210) and 8 belt packs (EXTREME Series).

### WBFC-210F

Extreme Series



#### Specifications

##### Dimensions/weight:

530x560x205 mm / 11.1 Kg Net  
(16 Kg full).

**Capacity:** 1 base station, 1 charger (WBPC-210), 4 belt packs (EXTREME Series) & 5 headsets\*

### WBFC-212F

Extreme Series



#### Specifications

##### Dimensions/weight:

530x560x295 mm / 14.5 Kg Net  
(21.9 Kg full).

**Capacity:** 1 base station, 2 chargers (WBPC-210), 8 belt packs (EXTREME Series) & 9 headsets\*

# Special antennas + accessories

## R-54135

Omnidirectional antenna

Original antenna supplied with ALTAIR wireless base stations.

### Specifications

**Directivity:** Omnidirectional; Gain: +5,5dBi.

**Frequency band:** 1850-1990 MHz.

**Mounting:** Connected to ALTAIR base stations or attached to the specific mounting accessories "AS-MB200" or "AS-MB200-2".

**Length:** 235mm.

**Connector:** Male SMA.



## R-54136

Small size omnidirectional antenna

Smaller omnidirectional antenna for ALTAIR base stations. Highly valued by professionals working in live events due to its higher resistance.

### Specifications

**Directivity:** Omnidirectional; Gain: +2,2dBi.

**Frequency band:** 1850-1990 MHz.

**Mounting:** Connected to ALTAIR base stations or attached to the specific mounting accessory "AS-MB-200" or "AS-MB200-2".

**Length:** 125mm.

**Connector:** Male SMA.



## DA-P6060

Directional antenna

This antenna can be used in large areas or when the base station can't be placed at the centre and must instead be placed at one end of an oval or rectangular shaped space. Another useful application of this model would be to improve wireless coverage inside a building by pointing the antenna to it from the outside.



### Specifications

**Directivity/ Gain:** 85° Horiz., 60° Vert. / +8dBi.

**Mounting:** screwed to a wall or on a microphone stand (using AS-MB200 mounting accessory, sold separately).

**Dimensions/weight:** 102x95x32 mm/ 110 gr Net.

## AS-MB200

Antenna mounting accessory



### Specifications

**Connectors:** 1 or 2 SMA connectors (female-female).

**Dimensions/weight:** 100x110x23 mm/120 gr Net.

Black finish "T" shape mounting accessory for ALTAIR antennas (ref. 54135, ref. 54136 or model DA-P6060) This mounting accessory can be attached to a microphone stand or screwed to a wall in fixed installations.

As seen in the images (up), two versions are available: AS-MB200 (1 antenna connector) and AS-MB200-2 (2 antenna connectors).

### Capacities:

**AS-MB200:** 1 x R-54135/R-54136 or 1 x DA-P6060

**AS-MB200-2:** 2 x R-54135/R-54136 or 1 x DA-P6060

## BC-0822

Omnidirectional high gain antenna

In order to complete the accessories' offer for its wireless intercom series, ALTAIR incorporates a new omnidirectional antenna. This antenna is ready for outdoor use in permanent installations or as a solution for mobile applications. The package includes a complete set of mounting accessories so that the user can install it on a wall or on a pole (please, see right a schematic depiction of the antenna and mounting accessory).



### Specifications

**Directivity/Gain:** 360° Horiz., 60° Vert. / +7dBi.

**Connectors:** 1 x female SMA.

**Dimensions:** 800 mm length.

**Dimensions/weight (packed product):** 850x100x100 mm/ 2 kg.

## ECXX-MM

Coaxial extension cable for antennas

Low losses coaxial extension cable. Available lengths: 3m, 5m, 10m, 20m, 30m and 40m (contact our Engineering Department if longer distances are required).



### Specifications

**Connectors:** male SMA at both ends.

## AS-2W

Antenna cable splitter

Passive splitter to divide an antenna cable into 2 separate branches. The use of this device leads to a decrease in the intensity of the signal, reason why it's recommended to restrict its use to situations in which it is absolutely necessary.



## SY-200

Synchronism cable

Interconnection lead for digital synchronism to be used when linking two or more WBS-200HD/202HD base stations.

Telephone cable ending with 2 x RJ11-6/4 pin to pin connectors.





## Wired intercom systems

E-200 Series

When designing an intercom network, choosing the right main station is crucial. *EF-200* dual channel station offers great features at a very compressed price, being perfect for small to medium installations.

The unit incorporates an internal worldwide operation power supply (variable voltage), capable of powering all the remote stations and belt packs connected to the intercom network (up to 50-60\*). This station offers the possibility of communicating with two independent channels, featuring separate "TALK" and "CALL" buttons plus a handy "A-B" listen balance (also, an "A+B" switch will join line B onto line A when required).

*EF-200* main station includes a program Input (MIC/Line) provided with attenuator and "assign" and "volume" controls. This program input can be assigned to any of the two channels.

Furthermore, the operator will be able to remotely execute actions such as "all mics off" (MIC KILL) and "all buzzers off" (BUZZ KILL) which will affect all the devices connected to this master station. A "MIC" output allows the user to send messages to the P.A. system from the headset or microphone connected to the base station.

Relay contacts are also provided, offering the installer several automation and remote control options ("tally" lights, speaker switching, cue lights activation, etc.)

"MULTICHANNEL LINK" connector allows the user to expand the number of channels of the system (2, 4, 6...) by connecting different stations in a MASTER-SLAVE setup. In this case, just the headset connected to the MASTER station will be needed to operate all the channels.

Finally, the station features an empty slot for an emergency battery which will allow operation of the intercom network during short power dropouts.

### EF-200

Dual channel wired intercom master station

#### Specifications

**Power Requirements:** 90-264 VAC/ 50-60Hz/ 50 VA.

**System Powering:** 24VDC / 1,8A / pin2.

**Emergency Powering:** 9V-PP3/ 1 hour (4 x *EM-201* intercom system).

**System Impedance:** 220 Ohm nominal / pin 3/ 2.000 meters maximum length.

**Connections:** Intercom line: XLR-3F & XLR-3M for both channels; PRG IN; P.A. OUT; XLR-4M headset connector.

**Dimensions/weight:** 1 x 19" RU x 210 mm/ 3 kg Net.

\* Maximum number of stations and belt packs that EF-200 can power might vary depending on cabling quality and lengths.



#### Key features

- System capacity: up to 50 x *EM-201* single channel belt packs.
- "MIC KILL" and "BUZZ KILL" functions.
- Independent "CALL" and "TALK" illuminated keys for each channel. Adjustable A-B listen control.
- Selectable LINK of both channels.

- *Multichannel link* function enables expandability of the system by adding more base stations (4, 6, 8 channels).
- Auxiliary socket for emergency battery.
- Relay contacts for remote control of *walkies*, *tally* lights, etc.
- Internal presets for mic gain, mic *phantom*, PRG interrupt, relay action, etc.



## EF-204

Four channels  
wired intercom  
master station

### Specifications

**Power requirements:** 90-264 VAC / 50-60Hz / 50 VA.

**System Powering:** 24VDC / 2.5 A / pin2.

**System Impedance:** 220 Ohm nominal / pin 3 / 2.000 meters maximum length.

**Connections:** Intercom line: XLR-3M & XLR-3F (channels A, B, C & D); 2 x RJ45 "ABCD"; PRG IN; PA OUT; mini jack "Audio Link" connectors; 2 x GPI & 2 x GPO; USB; Headset connector; Panel MIC connector.

**Dimensions/weight:** 1 x 19"RU x 250 mm / 4 kg NET.

ALTAIR *EF-204* base station is an all-in-one solution for those professionals requiring both ease of use, versatility and multiple channel operation capability. The power supply in this master station will power every device connected to the intercom network (up to 60 single channel beltpacks or 20 desk stations).

The four channels are provided with independent "TALK", "LISTEN", and "CALL" buttons. These channels can be linked using the front panel buttons.

This front panel includes a built-in high efficiency speaker and a connector for a removable *gooseneck* microphone (provided with the unit). When necessary, a headset can be used instead of the microphone.

The unit can work as a main station to control and power all the devices in the intercom network, or as a remote desk station in complex multichannel installations.

Thanks to a built-in digital processor, some features of all ALTAIR wired intercom devices can be remotely controlled from a base station. This way, the user at the master station can execute different actions which will affect every device connected to the intercom lines. These remote actions include "MIC KILL", "BUZZ KILL" and PTT/latch microphone switching.

*EF-204* station incorporates a program input (MIC/line) with level attenuator, assignable to any of the four channels, and a MIC output to address messages to the P.A. from the microphone or from a headset.

Also, relay contacts are included, being these associated to the "PA" button in order to help the installer automate multiple actions ("tally" lights, speaker switching, cue lights, etc.)

A section of four "key buttons" allows the user to store different presets for fast recall. The parameters that can be stored in these presets include all possible "TALK", "LISTEN" and "CALL" buttons states.

## Application example:

### Broadcast / Musicals

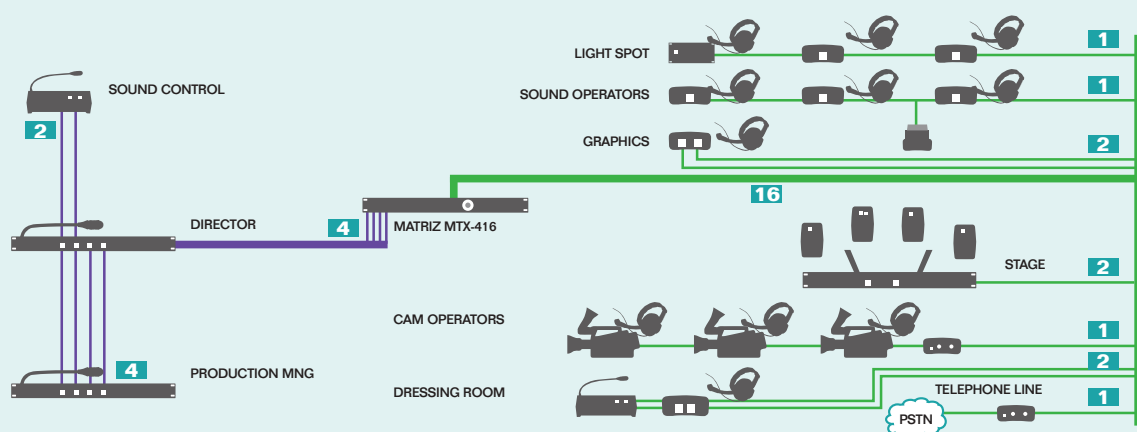

### Key features

- System capacity: up to 60 x *EM-201* single channel beltpacks.
- "MIC KILL" and "BUZZ KILL" remote functions.
- "CALL" and "TALK" illuminated keys per channel. Adjustable listen control.
- Switchable LINK between channels.
- Expansion connectors to link additional *EF-204* units.
- Relay contacts for remote control of *walkies*, *tally* lights, etc.
- Four programmable "key buttons".
- Upper panel access for advanced settings modification (MIC gain, *phantom* power, PRG interrupt, relay action, etc.)

### EM-201

Single channel beltpack

#### Specifications

**Powering:** 12-32 V, nom. 24V/ 35 mA.

**Connections:** intercom line: XLR-3F + XLR-3M.

**Headset:** XLR-4M.

**Dimensions/weight:** 84x38x105mm/ 235 gr Net.



This compact single-channel beltpack has been designed for intensive use in portable applications. A highly resistant plastic belt clip allows easy and comfortable adjustment of the beltpack. Visual and audio call signals (both functions can be turned ON & OFF independently). This unit can be adjusted to be used with dynamic or electret microphones, enabling the use of a wide variety of headsets in the market.

#### Key features

- Metallic (Aluminium) low-weight enclosure. Ergonomic shape. Plastic belt clip.
- ON/OFF MIC switch function (*push-to-talk* and latching options).
- Remote "MIC KILL" function (all mics off).
- Remote "BUZZ KILL" function (all buzzers off).
- "CALL" switch with illuminated signalling led.
- Microphone limiter for ear protection and fatigue-free communication.
- Selectable presets (MIC gain, *phantom*, limiter, etc.) via modification of internal jumpers allocation.

### EM-201FL

Single channel beltpack with beacon light

#### Specifications

**Powering:** 20-32 V, nom. 24V/ 140mA.

**Connections:** intercom line: XLR-3F + XLR-3M; Headset: XLR-4M.

**Dimensions/weight:** 84x88x105 mm/ 320 gr Net.

This unit offers the same functionalities of the EM-201, plus a high-luminosity Xenon beacon with 360° beam to help the operator notice calls in loud environments.



### EM-203 "Tubecom"

Compact size single channel unit

This revolutionary device is equipped with a small speaker and microphone, offering the possibility of a hands-free use in environments with a moderate ambient noise.

When the background noise gets louder the user can plug a headset to the unit, which will now operate as a regular wired intercom beltpack.

Thanks to its built-in speaker, this model allows one or various users to listen to the information shared on the *partyline* and participate actively on the conversation if necessary.



#### Specifications

**Powering:** 12-32 V, nom. 24V/ 35mA.

**Connections:** Intercom line: XLR-3M; Headset: XLR-4M.

**Dimensions/weight:** 135x31x26 mm/ 205 gr Net.

#### Key features

- Metallic (Aluminium) low-weight enclosure. Metallic belt clip.
- Built-in speaker and microphone.
- "ON/OFF" microphone switch (*push-to-talk* and latch modes).
- "MIC KILL" and "BUZZ KILL" functions.
- Illuminated "CALL" button.
- Microphone limiter for ear protection and fatigue-free communication.

## EM-202

Dual channel beltpack



ALTAIR EM-202 beltpack allows independent or simultaneous communication with two separate intercom channels.

The unit has been designed for intensive use in portable applications. A highly resistant plastic belt clip allows easy and comfortable beltpack adjustment. Call signalling is both visual and audible (both functions can be turned ON & OFF independently). This unit can be adjusted to be used with dynamic or *electret* microphones, allowing the use of different types of headset in the market. Listening balance between both channels (A/B) can be adjusted using a miniature fader.

This beltpack is available in two different versions: *EM-202-3P*, featuring 2 x 3-pin XLR connectors (one for each channel) and *EM-202-5P*, equipped with 2 x 5-pin connectors (both channels in the same connector). *EM-202-5P* allows the user to daisy-chain several units, while *EM-202-3P* is usually connected at the end of two intercom lines (A/B).

When using an *EM-202-3P* beltpack, an accessory splitter (*3MFM-200*) is necessary to continue the intercom line to other beltpacks (one splitter for each channel).

### Specifications

**Powering:** 12-32V, nom. 24V/50mA.

**Connections:** intercom line: XLR3 or XLR5 (depending on model).

**Headset:** XLR-4M.

**Dimensions/weight:** 84x38x105mm/ 270 gr Net.



EM-202-3P



EM-202-5P

### Key features

- Dual channel beltpack
- Listen balance adjustment (A, A+B, B).
- Metallic (Aluminium) low weight enclosure. Oval shaped. Plastic belt clip.
- On/Off MIC switch function (*push-to-talk* and latching options).
- Remote "MIC KILL" function (all mics off).
- Remote "BUZZ KILL" function (all buzzers off).
- Bright "CALL" switch with signalling led for each channel.
- Microphone limiter for ear protection and fatigue-free communication.
- External access for presets setup (MIC gain, *phantom*, limiter...)

## 5P3-202

5pin-3pin splitter/combiner



### Specifications

**Connectors:** Channels A & B: XLR-3M + XLR-3F; Channel A/B: XLR-5M+XLR-5F.

**Dimensions/weight:** 84x38x105mm/ 225 gr Net.

Interface to convert 2 separate 3-pin cables (one intercom channel in each one) into one single 5-pin cable with 2 separate intercom channels in it. The unit can also operate the other way around.

This unit can be used to simplify the installation when a dual channel beltpack must be placed far away from the base station. Using this device we will save lots of cable and the user will benefit from the possibility of daisy-chaining several dual channel beltpacks (EM-202-5P model).

The unit features an extension connector and a "power" led indicator per channel.



# Remote desk stations

E-200 Series

## ES-200

Dual channel desk station

### Specifications

**Powering:** 12-32 V, nom. 24V/ 70mA;

**Connections:** intercom line: XLR-3M & XLR-3F for each channel;

**Dimensions/weight:** 2 x 19" RU (310x89x79mm)/ 1,6 Kg Net.



The *ES-200* is a dual-channel remote station provided with a built-in speaker and gooseneck microphone. This remote station will act as a dual channel communication point in those environments where hands-free operation is preferred over the use of a headset.

The unit features 2 complete intercom channels, each one including an ON/OFF microphone switch (*push-to-talk* or latching modes) with an indicative led lamp. Apart from the built-in speaker and microphone, the unit features a male 4 Pin XLR connector, so that a regular intercom headset can be plugged when more privacy is required or when the environment is too loud. Connecting the headset will automatically switch off both the gooseneck microphone and the station speaker.

Like all the rest of the elements in the wired intercom network, the *ES-200* will be remotely powered from a base station or from a *PS-200* power supply.

As for the installing options, the unit can be inserted in a rack (2RU), embedded in a wall, or used as a desk station, all of this using the included multi-purpose rack ears.

Besides the usual intercom applications, the unit offers special functions such as the "remote messages" option and the remote "Mic-On", both controlled from the master base station. This unit is also a great complement to be used along with the *EF-200* master station when a hands-free solution is required.



### Key features

- Built-in loudspeaker and *gooseneck* microphone
- Automatic interruption of *gooseneck* microphone and speaker when a headset is connected
- "Latch" or "PTT" (*push-to-talk*) MIC functions
- Remote "MIC KILL" and "BUZZ KILL" functions
- Loud buzzer sound with volume control
- Microphone limiter for ear protection and fatigue-free communication.
- Feedback control using front panel controls
- Programmable functions: Remote speaker and remote microphone activation.

## ES-201

Single channel wall/desk station

### Specifications

**Powering:** 12-32 V, 60 mA.

**Connections:** intercom line CH-A: XLR-3M & XLR-3F; Micro USB; *Phoenix™* connectors.

**Dimensions/weight:** 2 x 1/2 19" RU (200x88x52mm) / 930 gr Net (aprox.).

*ES-201* station has been designed in response to the demand of in-wall stations for some specific installations. This unit features a full intercom channel, a built-in speaker and a panel microphone for hands-free operation.

The station also includes a headset connector, so that a regular intercom headset can be used when necessary. When connecting the headset, both the panel microphone and the speaker will be automatically shut down.

All setup changes of the unit are made using the front panel keys.

The optional mounting kit "OR-2-203" allows easy installation of 1 or 2 "ES-201" units in a 2 RU space.

NOTE: A similar dual-channel model ("ES-202") will be added to our catalogue in a near future.



### Key features

- Built-in panel microphone and speaker.
- Headset connection.
- ON/OFF/PTT microphone switch with led indicator.
- Both the microphone and *buzzer* can be remotely deactivated from a base station ("MIC KILL" & "BUZZ KILL" functions)
- Loud *Buzzer* with level adjustment and ON/OFF switch.
- Microphone limiter for ear protection and fatigue-free communication.



# Universal interface

## 4W2-200

Universal 4W/2W interface

### Specifications

**Powering:** 12-32 V, nom. 24V/ 25mA; **4W Connection:** balanced XLR-4M.

**Line Connection:** XLR-3M; **Telephone Line:** Standard RJ11.

**Dimensions/weight:** 84x38x140 mm/ 330 gr Net.

This single-channel interface converts bidirectional intercom line into 2 separate unidirectional (INPUT & OUTPUT) signals.

Thanks to this interface, the user will be able to connect ALTAIR systems to non-compatible intercom brands and it can be alternatively used to connect the intercom system to a telephonic line so that telephonic calls can be shared within the intercom partyline.

4W2-200 is also a great tool for connecting ALTAIR intercom systems to professional cameras CCU's.

By using this interface, a wide range of signals (mic or line) can be introduced to the intercom system, and the level of the signal coming out from the intercom line can as be as well easily adjusted for external operations (such as recording, post-production, etc.)



### Key features

- Remotely powered from the master station.
- Camera interfacing trough CCU connections.
- Telephone line interfacing.
- Interface for non-compatible intercom systems.
- Wide range level adjustments.
- Transformer-balanced INPUT & OUTPUT ensures clean signals and an improved EMI immunity.

## Bluetooth™ extension

### EB-200

Bluetooth extension

EB-200 station is a versatile device compatible with ALTAIR E-200 cable based intercom systems. It allows the operation of Bluetooth devices within the intercom network, being the connection as easy as in the case of a wired beltpack: just connect the EB-200 to the line and you are ready to work.

The device can be used in two main modes: "Headset mode", in which the intercom signal transmitted in full duplex to any compatible Bluetooth headset and "Interface mode", the intercom signal is transmitted to any compatible Bluetooth gateway device. The unit incorporates "MIC" and "EAR" level controls to allow adjustments in order to make it compatible with a wide range of devices in the market.

Regarding the applications, this unit can sometimes replace a wired beltpack in an intercom network, allowing wireless mobility for one user who's actually part of a wired intercom network. The use of "Class I" Bluetooth devices is strongly recommended in order to maximize the wireless range.

Interface mode allows sharing a mobile phone call within the intercom line. Another less typical application of this device could be the radio link of two nearby wired intercom systems by using two of these Bluetooth extensions.



### Specifications

**Powering:** 12-32 V, nom. 24V/ 100mA.

**Frequency Band:** BISM 2400 MHz/ Class I.

**Connections: intercom line:** XLR-3F + XLR-3M.

USB connection for firmware updates;

**Dimensions/weight:** 84x38x105 mm/ 250 gr Net.

### Key features

- Maximum theoretical range: 100 metres (when using Class I Bluetooth devices).
- Easy connection to ALTAIR wired intercom systems.
- Radio link to Bluetooth headsets (maximum one link per EB-200)
- Easy connection to mobile phones.

## Short Range Wireless Systems

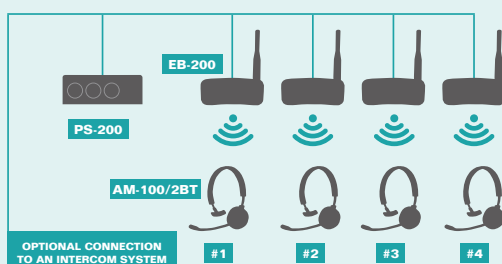

By using some EB-200, headsets and a PS-200 power supply we can deploy a small full-duplex wireless network.

## AM-100/2BT

Bluetooth single ear headset

Recommended Bluetooth single-ear headset to be used along with ALTAIR EB-200 Bluetooth extension.



### Specifications

**Power Supply:** USB connection.

**Range:** up to 30 meters; **Connections:** USB;

**Weight:** 283 gr Net.

**Charge Time:** 2 hours; **Autonomy:** 10 hours.



### FL-200

Accessory buzzer & beacon light

#### Specifications

**Powering:** 20-32 V, nom. 24V/ 100mA.  
**Connections:** intercom line XLR-3F + XLR-3M.  
**Dimensions/weight:** 84x88 x105 mm/ 300 gr Net.

This portable unit makes a perfect accessory for intercom systems operating in loud environments. Thanks to its high efficiency

Xenon light, the *FL-200* beacon will help the intercom operator notice the calls even in the loudest environments.

The unit is remotely powered from the base station, same way as a regular beltpack, and includes extension connectors so that it can be easily daisy chained to the intercom line. As in a regular beltpack, the "Buzzer" function is also included and can be turned on & off as required.

#### Key features

- Low weight metallic enclosure (aluminium).
- Selectable operation modes: Luminous warning, *Buzzer* or both functions simultaneously.
- Remote "BUZZ KILL" function (all buzzers off).
- High luminosity Xenon strobe with 360° beam
- Extended luminous warning helps notice incoming calls.

### PS-200

Intercom power supply for basic systems



#### Specifications

**Power requirements:** 90-264 VAC / 50-60 Hz/ 50VA;  
**Power to the system:** 24 VDC/1,8A;  
**Connections:** intercom line: XLR-3M for each line/channel. XLR-5M (both lines in one single connector);  
**Dimensions/weight:** 1 x 1/4 19" RU (42x110x150mm)/650gr Net.

This unit has been designed to power simple intercom systems. It includes connectors for two separate intercom lines in both 3 and 5 pin wiring setups.

A "LINK" switch allows joining both channels when necessary. "BUZZ KILL" function is also included (turns off all the buzzers in the system). This unit can't be used as a communication point as it does not include a headset connection.

#### Key features

- Stainless steel robust case.
- Dual channel power supply.
- "A+B" link and remote "BUZZ KILL" switches.
- Universal AC input range power supply.
- Optional rack mounting ears available (model *OR-1-200*, sold separately).

## Application example: basic configuration



### OR-1-200

Rack mounting accessory

This mounting accessory allows the installation of a *PS-200* power supply in a 1 RU space. The kit consists of a pair of rack ears, each one containing an empty slot to install ALTAIR wired intercom belt packs and/or interfaces.

Compatible devices: *PS-200*, *EM-201*, *EM-202*, *4W2-200*, *EB-200*, *5P3-202*, *EC-200* & *ER-200*.



## PC-4-200

One rack unit mounting accessory

This versatile panel allows the installation of up to four ALTAIR devices in 1 rack unit.

Compatible devices: *EM-201*, *EM-202*, *4W2-200*, *EB-200*, *5P3-202*, *EC-200* & *ER-200*.



## MF-200

Panel Microphone

### Specifications

**Microphone:** Dynamic "gooseneck" microphone.

**Connector:** XLR-4F.

**Dimensions/Weight:** 40 cm length / 180 gr Net.

This dynamic microphone is an alternative for those professionals requiring headset-free operation. The operator will now be able to move freely, easily orienting the microphone thanks to its flexible neck. When the situation requires it, this microphone can be removed in order to plug in a headset. When using the *MF-200* microphone, the operator must use an external audio monitor connected to the base station in order to listen to the *partyline* (unless using an *EF-204* station, which is equipped with a built-in speaker).



# Intercom headsets *(equipped with standard size XLR-4F connector)*

## AM-100/2

Single muff headsets



Our most demanded headset model. Professional quality, high durability single-ear headset. High noise isolation thanks to its closed design; dynamic microphone for higher durability.

### Specifications

**Microphone:** dynamic, cardioid, 200 Ohm.  
**Headset:** WAM-100/2 -> 400Ω;  
 WAM-100 -> 200 Ohm (2 x 400 Ohm).  
**Weight:** WAM-100/2 -> 245 gr Net;  
 WAM-100 -> 330 gr Net.



## AM-100

Double muff headsets



Professional quality, high durability dual-ear headset. High noise isolation thanks to its closed design; dynamic microphone for higher durability.



## AM-100/2S

Single muff headsets w/rotating microphone



Our most complete series of headsets. Professional quality single-ear headset featuring extra noise isolation. Rotatable microphone boom acting as microphone "on/off" switch. Recommended model for loud environments.

### Specifications

**Microphone:** dynamic, cardioid, 200 Ohm.  
**Headset:** WAM-100/2S -> 400Ω.  
 WAM-100S -> 200 Ohm (2 x 400 Ohm);  
**Weight:** WAM-100/2S -> 350 gr Net;  
 WAM-100S -> 450 gr Net.



## AM-100S

Double muff headsets w/rotating microphone



Our most complete series of headsets. Professional quality dual-ear headset featuring extra noise isolation. Rotatable microphone boom acting as microphone "on/off" switch. Recommended model for loud environments.



## AM-100/2SEC

Earphone

### Specifications

**Description:** in-ear lightweight headset with *electret* microphone.  
**Dimensions/weight:** 170x80x30 mm (packed) / 33 gr Net.



Intended for those applications requiring a discrete solution in a very small size.

This in-ear model features an *electret* microphone with two operation modes: "PTT" (push-to-talk) and "VOX" (always active). *Phantom* power required (provided by the beltpack).

## AM-100/2L

Single muff lightweight headsets

### Specifications

**Description:** in-ear lightweight headset with *electret* microphone.  
**Dimensions/ weight:** 165x189x55 mm (packed) / 73 gr.



Lightweight headset with *electret* microphone, perfect for office environments or when the use of a standard intercom headset is not possible due to aesthetic reasons. This model is not suitable for too loud environments. *Phantom* power required (provided by the beltpack).

# Intercom/audio switching matrix

## MTX-416

Programmable 4x16 switching matrix

## Specifications

**Powering:** 90-264 VAC/ 50-60Hz/ 20 VA.

**Connections:** 20 x 3 pin *Phoenix™* connectors, IDC expansion, RJ45 control, USB (connection to PC);

**Bandwith/crosstalk:** DC-20KHz / > 80dB;

**Dimensions/weight:** 1 x 19" RU x 160mm/ 5Kg NET.



Designed to be used at medium to large installations, ALTAIR *MTX-416* is a programmable switching matrix that allows instant recall of up to 5 different presets. Each preset determines the assignment of the different intercom or audio channels onto the 16 available lines. This way, a beltpack or station connected to any of these 16 lines will be fed by the selected channel.

This matrix operates in vertical and exclusive mode, which means that an intercom device (or line of devices) connected to one of the 16 terminals, can be assigned exclusively to one of the 4 available intercom channels that feed the system.

The power for all the elements connected to the 16 lines is remotely provided by the 4 intercom channels connected to the matrix. Input and output "LINK" connectors are provided for easy "X" and "Y" expansion of the number of channels or lines.

The use of a *MTX-416* allows safe and instant reorganization of the full intercom network. Also, this device allows the administrator to easily modify the assignment of channels thanks to its highly intuitive interface.

ALTAIR *MTX-416* can also be used as a 4 in/16 out audio matrix, or as a 16 in/4 out matrix selector when used in reverse mode.

## Key features

- 4 intercom channels to 16 lines.
- 5 instant recall presets.
- Easy operation and setup.

- "X" & "Y" (horizontal & vertical) expandability of the matrix.
- USB interface. Remote I/O controls.
- Compatible with any wired party line intercom system.
- Operation as 4x16 or 16x4 audio matrix.
- *Phoenix™* connectors.

## Application example MTX-416

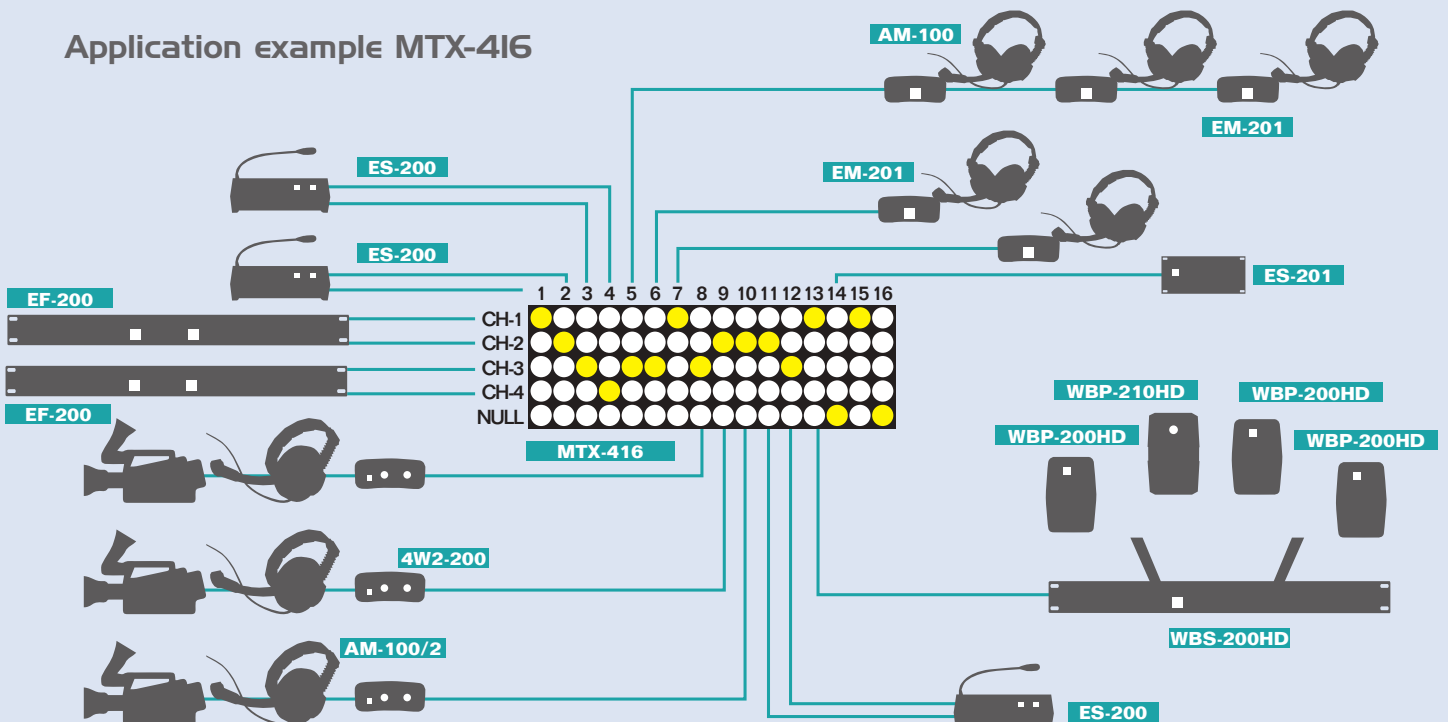

# Cue Light Series

Intercom systems are used for a wide variety of applications, comprising such different environments as theatres, TV studios, sport fields or surgery rooms. Adapting to the changing needs of the professionals and with the purpose of adding versatility to our intercom systems, we have designed an intuitive, resistant and easy to use cue light system.

## EC-200

*Cue Light* master unit

### Specifications

**Powering:** 12-32 V, nom. 24V/ 50 mA.

**Connections:** intercom line (INPUT) XLR-3M / Intercom + Cue XLR-3F & XLR-3M / micro USB for firmware updates.

**Dimensions/weight:** 84x38x105 mm / 225 gr Net.



### Key features

- Single channel *cue light* master control unit.
- Powered from the intercom line or from a *PS-200* power supply.
- Compatible with *PC-4-200* rack mounting.
- Standard microphone *XLR-3* wiring.

This master unit operates as the main control for the whole cue light system (1 channel). It will be typically operated by a coordinator or stage manager. With the same shape and size of a wired intercom beltpack, the *EC-200* can be easily installed in a *PC-4-200* panel. This way, several units can be installed together in a 1RU panel, allowing the user to create a multi-channel cue light control station (see image below).

The unit is powered from the intercom line, or from a *PS-200* power supply when operating in standalone mode.

This cue light system works with a FSK modulated carrier, superimposed and transparent to the audio and signaling line.



### Application example "standalone" mode:

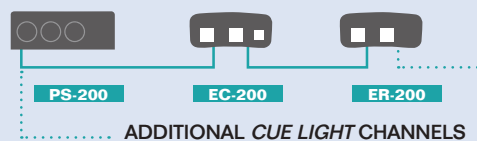

**Note:** Different cue light channels could be combined in the same intercom line or *PS-200* power supply.

## ER-200

Standalone *Cue Light* receiver

Remote cue light signals receiver for standalone use (no intercom operation). Similar shape to *EC-200* Master Unit for easier installation and compatibility with mounting accessories.

The unit includes a "STBY" illuminated switch and a "GO" illuminated indicator.

The cue system is normally designed as one transmitter and one receiver per channel but sometimes it can be used as a "partyline cue", where up to 8 receivers are connected to a single master unit. In this case, every action is executed sequentially and the operator of each receiver will press the "STBY" key (READY) so that the warning goes on to the next receiver.

### Specifications

**Powering:** 12-32 V, nom. 24V/ 50 mA.

**Connections:** INPUT (Intercom + Cue) XLR-3F and OUTPUT (Intercom + Cue) XLR-3M.

**Dimensions/weight:** 84 x 38 x 105mm/ 225 gr Net.

### Key features

- Single channel *Cue Light* receiver
- Powered from the master control unit *EC-200*.
- Operation modes: Standalone receiver or with additional receiver units in daisy-chain.
- Compatible with *PC-4-200* rack mounting.
- Standard microphone *XLR-3* wiring.



## ES-203CL

Wall desk station with *Cue Light*

This wall/desk unit consists on a 2-channel wired intercom station plus a cue light signals receiver, all in a compact-size device.

The unit includes a panel microphone and a speaker, which are very handy when using the system as an in-wall device for remote positions such as dressing rooms. A headset connector is also included (auto headset detection system disables panel speaker and microphone when a headset is connected to the unit).

This unit is compatible with *gooseneck* microphone *MF-200* (sold separately).

The unit incorporates supports to fix to a table/wall with different inclination angles.

By a combination of keys you could configurate the general settings: *phantom* for *electret* mics, PTT, remote volume, remote mic activation, etc. No internal configuration jumpers/switches anymore.

Rear pannel incorporates XLR and *Phoenix™* 3,5mm connectors to adapt the unit to reduced rear space (wall mounting).

Unit incorporates a rear panel "assistant mode" switch enabling power and communication to an assistant operator connected to the CH-B intercom line. This way the assistant is in private conversation with the *ES-203* operator, non sharing main CH-A channel.

The optional mounting kit "OR-2-203" (see right) allows easy installation of 1 or 2 "EC-203CL" units in a 2 RU space (sold separately).

## Specifications

**Alimentación:** 12-32 V, 90 mA.

**Powering:** 12-32 V, 90 mA.

**Connections:** Cue + Intercom line CH-A: XLR-3M & XLR-3F; Intercom line CH-B: XLR-3M & XLR-3F; CH-A/CH-B: *Phoenix™* connectors; Micro USB; Embedded XLR-4M headset connector.

**Dimensions/weight:** 2 x ½ 19" RU (200x88x52mm) / 1 kg Net.

## Key features

- Unit setup (electret, PTT, remote volume, remote mic ON, etc.) via key combinations (no internal adjustments required).
- Rear panel includes XLR and 3,5mm *Phoenix* connectors to be used when space is a limitation (in-wall installation).
- An external jumper sets CH-B line powering from CH-A, for installations where an auxiliary line for an assistant operator is necessary.
- Optional mounting kit "OR-2-203" allows easy installation of one or two "ES-203CL" units in a 2 RU space.



## Application example with an intercom system:

